

---

Thank you for choosing SAIC MAXUS Automotive Co.,Ltd. May our products and services bring fresh joy to your life!

Please take time to read and understand this Handbook and other publications supplied with it. Thus you can familiarize yourself with the vehicle and enjoy a driving experience with comfort, safety as well as economy.

This Driver's Handbook will provide you with the information necessary for getting familiar with your vehicle, including how to drive the vehicle, how to carry out routine maintenance checks, and what to do in an emergency.

This Handbook contains the latest information upon the time of printing and all modifications, interpretations and explanations should be reserved by the company. Based on the consideration that the products will be upgraded or in any other way(s) modified constantly, the company reserves the right to apply these changes mentioned here before without notice when the Handbook has been hereby printed and published and will accept no liability.

This Handbook is an indispensable part of the vehicle. If you want to sell the vehicle, please remember to provide the new owner with this Handbook.

## **Special Announcement**

Driver's Handbook and Warranty & Service Handbook specify the agreement between the company and the user on establishment and termination of rights and obligations concerning the quality warranty and after-sales service of product. Please be sure to read the Driver's Handbook and Warranty & Service Handbook carefully before using the product. If any damage is caused by misuse, neglect, incorrect operation or unauthorized refit, the user will have no right of claim, and any warranty request will be refused by SAIC MAXUS Automotive Co.,Ltd Service Dealer(hereinafter referred to as "Service Dealer").

Unauthorized re-production of this Handbook, whether electrically, physically or in any other way, and/or storing the Handbook in any inquiry system of any form or type shall not be permitted.

Wish you a pleasant driving!

SAIC MAXUS Automotive Co.,Ltd. Address: #2500, Jun Gong Road, Yang Pu District, Shanghai Postcode: 200438

SAIC MAXUS Automotive Co.,Ltd reserves the final right to interpret this Handbook

---



# Contents

<b>Perface</b> .....	<b>1</b>	Manual unlocking/locking of doors .....	16
<b>Introduction</b> .....	<b>1</b>	<b>Windows</b> .....	<b>20</b>
About this handbook .....	1	Power windows .....	20
Indicative information .....	1	<b>Seats</b> .....	<b>21</b>
<b>Precautions</b> .....	<b>3</b>	Driver and front occupant seat adjustment.....	21
Dangerous substances.....	3	Seat heater (if equipped).....	22
Children / Animals .....	3	Headrest.....	23
Personal safety.....	3	<b>Occupant restraint system</b> .....	<b>23</b>
<b>Vehicle identification</b> .....	<b>4</b>	Sitting correctly.....	23
Vehicle identification number (VIN) .....	4	Seat belt .....	24
Drive motor type and number.....	4	Seat Belt Pretensioner .....	25
VIN plate.....	5	Airbag(s).....	26
<b>Instructions for using electric vehicle</b> .....	<b>6</b>	Child restraints (not supplied with the vehicle).....	28
Ambient temperature for using vehicle.....	6	<b>Instruments and controls</b> .....	<b>29</b>
Driving range .....	6	<b>Instrument cluster</b> .....	<b>30</b>
Equalizing charge.....	7	Speedometer.....	30
Recycle instructions for high-voltage battery packs .....	7	Drive motor power percentage table .....	30
High voltage system.....	8	Voltmeter of high-voltage battery pack.....	30
Instructions when accident occurs .....	9	Information center .....	31
<b>1 Before You Drive</b> .....	<b>11</b>	Display brightness adjustment .....	33
<b>Keys</b> .....	<b>12</b>	<b>Warning lights and indicators</b> .....	<b>34</b>
Ordinary key .....	12	Direction indicator.....	34
Remote key .....	12	Headlamp main beam indicator.....	34
Extension/retraction of mechanical key portion of the remote key ('mechanical key portion' for short).....	13	Rear fog light indicator .....	34
Replace the battery in remote key.....	13	Position light indicator .....	34
<b>Door locks</b> .....	<b>14</b>	Door open warning light .....	34
To protect your vehicle against theft.....	14	Seat belt warning light .....	34
Central door locking system .....	15	Airbag warning light.....	34
		Brake system warning light .....	35

# Contents

ABS (Anti-lock Braking System) warning light.....	35	<b>SOS alarm switch .....</b>	<b>43</b>
EBD (Electronic Brake Distribution) warning light.....	35	<b>Switches on steering column and steering wheel .....</b>	<b>44</b>
ESP (Electronic Stability Program) indicator.....	35	Power switch and steering lock.....	44
ESP (Electronic Stability Program) OFF indicator.....	36	Combination light control & direction indicator lever switch .....	44
Electric power steering fault warning light.....	36	Wiper and washer lever switch.....	46
Drive motor overheat warning light.....	36	Cruise switch.....	48
Power system fault warning light.....	36	Voice control and bluetooth phone switch.....	48
High-voltage battery pack cutoff warning light.....	36	Horn.....	49
High-voltage battery pack low battery warning light.....	36	<b>Steering wheel adjustment .....</b>	<b>50</b>
High-voltage battery pack fault warning light.....	37	<b>Heating, ventilation and air conditioning (HVAC).....</b>	<b>50</b>
Charging connection indicator.....	37	Front ventilation.....	51
Charging status indicator.....	37	Front manual AC control panel (heating & cooling).....	52
READY indicator .....	37	Front automatic AC control panel (heating & cooling).....	53
Battery charging indicator.....	38	Air conditioning operating tips .....	55
Insulation fault warning light .....	38	<b>Rear view mirrors .....</b>	<b>56</b>
Limited power indicator .....	38	Exterior rear view mirrors .....	56
Cruise control indicator.....	38	<b>Internal equipment.....</b>	<b>57</b>
TPMS warning light .....	38	Roof vanity light.....	57
FCW (Forward Collision Warning) warning light/AEB (Automatic Emergency Braking) warning light .....	38	USB port.....	58
LDW (Lane Departure Warning)/LKA (Lane Keep Assist) /ELK (Emergency Lane Keeping) warning light.....	39	12V power outlet .....	59
SLIF (Speed Limit Information Function) indicators .....	39	Glove box .....	60
<b>Instrument cluster switch .....</b>	<b>40</b>	Sun visors.....	60
Headlamp leveling switch.....	40	Driver's tools.....	61
ESP OFF switch.....	40	<b>Entertainment system.....</b>	<b>62</b>
AVAS switch .....	41	Precautions before use .....	62
ECO switch.....	41	<b>2 Starting and Driving .....</b>	<b>65</b>
REG switch.....	42	<b>Before starting and driving.....</b>	<b>66</b>
Heated rearview mirrors switch .....	42	<b>Power switch .....</b>	<b>66</b>
Hazard light switch .....	43	<b>Starting / Stopping.....</b>	<b>67</b>

# Contents

Starting .....	67	Warning lights .....	93
Stopping .....	67	<b>Cruise control system .....</b>	<b>93</b>
<b>Driving .....</b>	<b>68</b>	Cruise control settings .....	94
<b>Gear shifting .....</b>	<b>69</b>	Terminating cruise control .....	95
Shift operation .....	69	Clearing speed memory .....	95
Auto park (Automatically return to P gear) .....	70	<b>Parking assist system .....</b>	<b>96</b>
<b>Charging requirement.....</b>	<b>71</b>	Parking sensor .....	96
Requirements for charging equipment .....	72	Parking camera .....	97
Safety instructions for charging with residential electricity .....	72	<b>Driver assistance system .....</b>	<b>98</b>
Requirements for charging environment .....	74	Camera.....	98
Influence of charging operation on special personnel .....	74	FCW and AEB (Forward collision assist) .....	99
Charging mode.....	75	LDW (Lane Departure Warning).....	102
Fast charging.....	76	LKA (Lane Keeping Assist) .....	104
Slow charging.....	78	ELK (Emergency Lane Keeping).....	105
Charging information .....	83	SLIF (Speed Limit Information Function).....	107
Equalizing charge.....	83	<b>Tires .....</b>	<b>109</b>
Charging time .....	83	Winter tires .....	109
<b>Exterior discharge .....</b>	<b>84</b>	Anti-skid chain .....	110
Discharge requirements .....	84	<b>Loading .....</b>	<b>110</b>
Requirements for discharge environment .....	85	<b>Trailer towing .....</b>	<b>112</b>
Discharge operation .....	85	Recommended towing weight .....	114
<b>Acoustic vehicle alerting system (AVAS) .....</b>	<b>86</b>	Installation of trailer device.....	115
Acoustic vehicle alerting system (AVAS) sound effect .....	87	Maintenance.....	115
<b>Electric power steering unit.....</b>	<b>87</b>	<b>3 Emergency Troubleshooting .....</b>	<b>117</b>
<b>Brake system .....</b>	<b>88</b>	<b>Hazard light.....</b>	<b>118</b>
Service brake .....	88	<b>Warning triangle .....</b>	<b>118</b>
ABS (Anti-lock braking system).....	89	<b>Self-service tire repair .....</b>	<b>119</b>
ESP (Electronic Stability Program).....	90	Usage.....	120
Parking brake .....	92	<b>Wheel replacement .....</b>	<b>125</b>

# Contents

Jack.....	125	Inspection and refill .....	148
Spare tire.....	125	<b>Brake fluid.....</b>	<b>149</b>
Replacing tire .....	128	Inspection and refill .....	149
<b>Towing .....</b>	<b>130</b>	<b>Washer fluid.....</b>	<b>150</b>
Towing hitch.....	130	Inspection and refill .....	150
<b>Jump start.....</b>	<b>132</b>	<b>Washer jet .....</b>	<b>151</b>
<b>Replacing fuse .....</b>	<b>133</b>	Adjusting and cleaning .....	151
Driver compartment fuse box .....	134	<b>Wiper blade .....</b>	<b>151</b>
Front compartment fuse box .....	135	Inspection.....	151
Battery fuse box .....	137	Replacement .....	152
Replacing fuse.....	138	Maintenance and service .....	152
<b>Replacing bulbs.....</b>	<b>139</b>	<b>Seat belt.....</b>	<b>152</b>
Bulb specification .....	139	Inspection.....	152
Low beam.....	140	Maintenance and service .....	153
High beam, position light.....	140	<b>Battery .....</b>	<b>153</b>
Front turn signal light.....	141	Duration of storing the vehicle.....	155
Front roof vanity light.....	141	Operating in winter .....	155
Rear roof vanity light .....	142	Recharging the battery with ground equipment.....	155
<b>4 Maintenance and Service.....</b>	<b>143</b>	Removing the battery .....	156
<b>Scheduled maintenance .....</b>	<b>144</b>	Replacing the battery .....	156
<b>Owner's check .....</b>	<b>144</b>	Installing the battery .....	156
Daily checks .....	144	<b>High-voltage battery pack.....</b>	<b>157</b>
Weekly checks or check before a long journey .....	145	Instructions and restricted conditions .....	157
Arduous use .....	145	<b>Tires .....</b>	<b>159</b>
<b>Front compartment.....</b>	<b>145</b>	Tire pressure .....	159
<b>Front compartment hood.....</b>	<b>146</b>	Wear indicator .....	160
Open front compartment hood .....	146	Tire check and rotation.....	161
Close front compartment hood .....	147	<b>Other maintenance .....</b>	<b>161</b>
<b>Coolant .....</b>	<b>148</b>	Vehicle cleaning .....	161

# Contents

---

Anti-corrosion of underbody .....	162
Seat and trim .....	162
Door seal .....	162
Window glass .....	162
<b>5 General Technical Parameters .....</b>	<b>163</b>
<b>Major vehicle dimension parameters .....</b>	<b>164</b>
<b>Vehicle weight parameters .....</b>	<b>165</b>
<b>Dynamic performance parameters .....</b>	<b>166</b>
<b>Major drive motor parameters .....</b>	<b>167</b>
<b>Chassis technical parameters .....</b>	<b>168</b>
<b>Recommended fluids .....</b>	<b>169</b>
<b>Wheel and tire .....</b>	<b>170</b>
<b>Wheel alignment parameters .....</b>	<b>171</b>





# Preface

---

## Introduction

### About this handbook

This Handbook applies to MAXUS e DELIVER 3 series of pure electric vans and cabs.

Caution
IMPORTANT: The information contained in this Handbook is designed to cover more than one model option and variant, and therefore some of the items mentioned here may not apply to your vehicle.

The applicable executive enterprise standard is Q31/0110000019C032.

The illustrations in this Handbook are for reference only.

## Indicative information

### Warning



**This symbol indicates that: In order to avoid the possibility of personal injury or injury to others, relevant procedures must be followed strictly and precisely.**

### IMPORTANT

Caution
Relevant procedures must be followed to avoid the possibility of vehicle damage.

# Preface

---

## Note

**Note:** *Indicative statements which provide helpful information.*

## Environment protection



**We are all expected to play our part in protecting the environment. This symbol draws attention to information which may help you to do that.**

## Arrows



It indicates the described object.



It indicates the moving direction of an object.

## See

The contents are referred by the "Section" title.

## Precautions

### Dangerous substances

 Many liquids and other substances used in motor vehicles are poisonous and should under no circumstances be consumed and should, so far as possible, be kept away from open wounds. These substances among others include battery acid, anti-freeze, brake fluid, washer fluid, lubricants, refrigerant and various adhesives. Always read carefully the instructions printed on the labels or stamped on components and obey them implicitly. These instructions are for the sake of your health and personal safety. Please treat them with prudence.

For your safety, observe instructions contained in this Handbook.

## Children / Animals

 Accidents and injury may be caused by unsupervised children or animals operating controls and switches fitted to your vehicle, or playing with equipment or goods being transported in it.

To prevent child or animal induced accidents or personal injury, Do NOT leave them unattended inside the vehicle without adult supervision. Also they can become suffocated in hot weather conditions.

## Personal safety

 Seat belts are fitted to all seats in your vehicle to reduce the possibility of personal injury in the event of an accident. It is required that all occupants wear a seat belt. In addition, a Supplementary Restraint System (SRS) is installed for additional protection of the driver and front occupant, comprising air bags and seat belt pretensioners.

See "Occupant restraint system". Misuse of an air bag can result in injury.

# Preface

## Vehicle identification

When communicating with our Service Dealer, you should provide the vehicle identification number (VIN).

### Vehicle identification number (VIN)

Vehicle identification number (VIN) on the vehicle:

- On the front of the front shock absorber mounting tower (seal position).
- On the VIN plate on the right B pillar.
- At the lower left of the windshield.

This vehicle is equipped with an OBD data link connector, located under the left instrument cluster. You can contact our Service Dealer to read VIN information from the electronic control unit with the special equipment.

#### Type 1

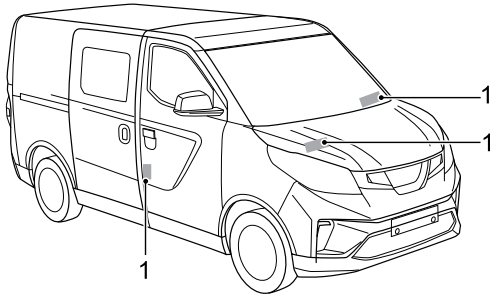

#### Type 2

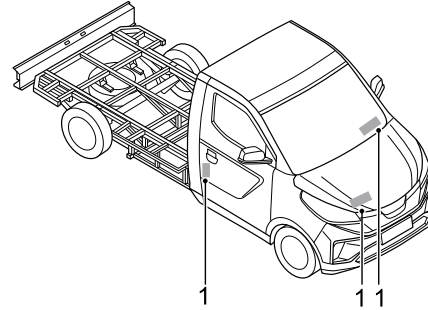

1 Vehicle identification number (VIN)

### Drive motor type and number

The drive motor type and number are printed on the shell of the drive motor.

# Preface

---

## VIN plate

VIN plate may contain the following information, please refer to the actual vehicle.

- The manufacture's company name
- The whole vehicle type-approval number
- VIN
- The technically permissible maximum laden mass
- The technically permissible maximum mass of the combination
- The technically permissible maximum mass on each axle listed in order from front to rear

## Location of VIN plate

The VIN plate (1) is located at the front of the right B pillar.

### *Type 1*

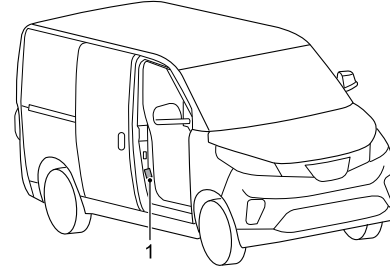

### *Type 2*

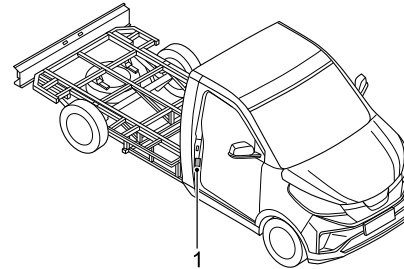

## Instructions for using electric vehicle

### Ambient temperature for using vehicle

The working performance of the high voltage battery pack in the power system of the vehicle is related to ambient temperature, so it is recommended to use the vehicle at the ambient temperature from -15°C to 45°C, to ensure the vehicle in the best working status and extend the life of the high-voltage battery pack. High or low temperature will affect the performance of the high-voltage battery pack and the vehicle. The working temperature range of the power battery is -30°C to 60°C, and the battery cannot work normally beyond the working temperature range. In the cold weather, it is recommended to store the vehicle in a warm house or park it nearby the charging pile for heating the battery by the connector before use, to avoid affecting traveling.

### Driving range

Driving range depends on the battery capacity available to the vehicle, the age of the vehicle (service life of the current battery), weather, temperature, road condition, driving habits, etc. Please note:

- Driving range is related to the depth of discharge (DOD). To avoid high DOD affecting the performance of high-voltage battery pack, it is recommended that you recharge the battery in time upon seeing the illuminated "high-voltage battery pack low battery warning light" on the instrument cluster.
- The actual driving range decreases with the increase of the age of the vehicle.
- The use of air conditioning will reduce the driving range.
- The driving range varies with the speed.
- When the vehicle is used at low temperatures, the driving range will be reduced due to temperature characteristics of the battery.
- In the case of extreme temperatures and low battery, weak acceleration or lack of power may occur due to battery characteristics. Driving range can be increased by:
  - Having the vehicle maintained regularly;
  - Maintaining proper tire pressures;
  - Using the vehicle as few as possible at high or cold temperatures.
  - Charging the battery at once after the vehicle is stopped in winter;
  - Lightening the load by removing unnecessary items;
  - Turning off high-power electrical equipment such as the air conditioning, or adjusting the heating or cooling base temperature as necessary to minimize the energy consumed by high-power electrical equipment and increase the driving range.
  - Closing the windows under the condition that the vehicle is running at a high speed, so as to reduce air resistance and power consumption.

# Preface

---

- Keeping a steady speed.
- Depressing the accelerator pedal as lightly as possible while accelerating.
- Releasing the accelerator pedal and not applying the brakes or depressing the brake pedal lightly during deceleration to allow the energy regeneration system to increase the driving range as much as possible.

## Equalizing charge

Equalizing charging means that during the charging process, under the action of the battery management system, the voltage of each cell is basically the same, so as to ensure the overall performance of the high-voltage battery pack. Therefore, it is recommended to charge the vehicle at least once a month with a slow full charge of less than 25% of its battery capacity to improve battery performance and lifespan.

## Recycle instructions for high-voltage battery packs

The high-voltage battery pack mounted at chassis position contains many lithium cells. Arbitrary disposal may cause pollution and harm to the environment. It is forbidden to dismantle and discard without approval. It will be disposed of by professional institution. Please refer to the following information or requirements for recycling. Details about recycling and disposal of high-voltage battery pack can be obtained through consulting our Service Dealer.

- Personnel requirements: Dismantling must be done by qualified professionals.
- High voltage safety: Insulation protection measures must be adopted for internal high-voltage components such as lithium batteries and high-voltage harnesses before uncovering or dismantling.
- Transportation: High-voltage battery packs are classified as Class 9 dangerous goods and must be transported by vehicles qualified for the transportation of Class 9 dangerous goods.
- Storage: The removed high-voltage battery pack should be stored in a dry, room temperature environment, away from inflammables, heat sources, water sources and other hazard sources.
- Internal composition: The high-voltage battery pack consists of a series of components such as lithium cells (batteries), circuit boards, electric wires and metal shells.

# Preface

---

It is recommended that you hand over the used high-voltage battery pack due to vehicle scrapping or other reasons to the recycling service outlet designated by our company for disposal. Details about servicing, recycling and disposal of high-voltage battery pack can be obtained through consulting our Service Dealer.

***Note: In case of environmental pollution or safety accidents caused by handing over the used high-voltage battery pack to another unit or individual, or removing and dismantling the high-voltage battery pack without permission, the owner of the high-voltage battery pack shall bear the corresponding responsibilities.***

## High voltage system



**High-voltage system on vehicle includes AC and DC high voltage power (can reach over 460V).**

**High-voltage power is very dangerous and may cause serious injury such as burning, electric shock and even death.**

- It is prohibited to contact high-voltage cables and its connectors to avoid personal injury.
- Parts with orange labels are parts of high-voltage system. These parts are equipped with warning label of high-voltage system. Requirements on warning label of high-voltage system must be abided by.
- It is prohibited that non-professional repair personnel contact, disassemble or install any components of high-voltage system without approval.



## Instructions when accident occurs



- Keep the vehicle in P, and turn off the ignition switch.
- If cables on the vehicle are exposed or damaged, it is forbidden to contact any cable to prevent electric shock.
- If fire disaster occurs, personnel shall immediately leave the vehicle and use ammonium carbonate salt fire extinguisher to put out the fire or use lots of water to put out the fire. It is strictly prohibited that any person contacts or enters ignited vehicle during the rescue period. After fire has been put out, continuous observation is required. Professional personnel will remove the vehicle to spacious area after confirming power battery does not have abnormal sound and smoke. Professional personnel will confirm battery state before vehicle transfer.
- If the vehicle is collided, the vehicle shall not be re-started. In addition, the negative battery cable will be disconnected when rescuing.
- When vehicle is completely or partially immersed into water, personnel will turn off the vehicle and timely escape. The negative battery cable will be disconnected before transporting vehicle that has been refloated. If there is not bubble or abnormal sound when refloating, refloating operation can

be conducted; if there is bubble or abnormal sound, operation can be conducted when there is not bubble or abnormal sound.

- After accident has been disposed of, please contact our Service Dealer.



## Before You Drive

---

- 12 Keys
  - 14 Door locks
  - 20 Windows
  - 21 Seats
  - 23 Occupant restraint system
  - 29 Instruments and controls
  - 30 Instrument cluster
  - 34 Warning lights and indicators
  - 40 Instrument cluster switch
  - 43 SOS alarm switch
  - 44 Switches on steering column and steering wheel
  - 50 Steering wheel adjustment
  - 50 Heating, ventilation and air conditioning (HVAC)
  - 56 Rear view mirrors
  - 57 Internal equipment
  - 62 Entertainment system
-

# Before You Drive

## Keys

The vehicle is equipped with 1 ordinary key and 1 remote key or 2 remote keys.

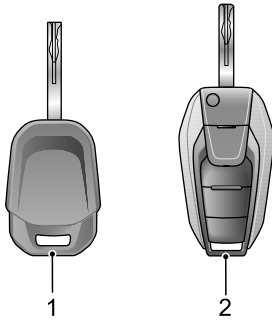

- 1 Ordinary key
- 2 Remote key

**Note:** *In case of loss, replacement keys are available from our Service Dealer by quoting the key number on the metal or plastic tag supplied with the keys. We recommend you should keep the metal or plastic tag in a safe place.*

**Note:** *For the sake of safety, the key are coded electronically to your vehicle's immobilizer system and are unique to it. A special procedure is required to replace keys. The uncoded key cannot start the vehicle and can only be used to lock/unlock doors.*

## Ordinary key

The ordinary key is primarily for activating the immobilizer system and starting systems, but will also lock/unlock the driver's door and the tail gate. Use of an ordinary key in either of these doors (driver's door excluded) will lock/unlock that door only.

For further information on the use of ordinary key see "Manual unlocking/locking of doors" and "Power switch and steering lock".

## Remote key

The remote key is the controlling part of your vehicle's central locking system, and its use enables you to lock/unlock all doors.

**Note:** *The remote key is coded electronically to your vehicle's locking/unlocking system and is unique to it. A special procedure is required to replace remote keys. Our Service Dealer will be pleased to assist you.*

For further information on the use of the remote key see "Central door locking system".

### Caution

The immobilizer system can accept 8 coded keys at most (including ordinary keys and remote keys).

## Before You Drive

### Extension/retraction of mechanical key portion of the remote key ('mechanical key portion' for short)

#### Mechanical key portion

Press the release button on the remote key to extend the mechanical key portion from the key itself.

To retract the mechanical key portion, press the release button on the remote key and rotate the mechanical key portion back to the key itself.

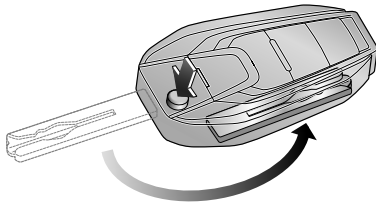
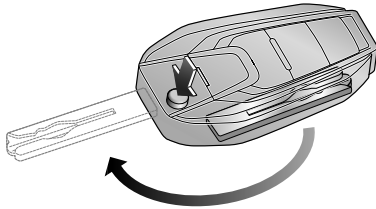

### Replace the battery in remote key

 Batteries present danger, risk of fire, explosion and burns. Do not attempt to re-charge batteries. Properly dispose of the used battery. Keep the battery out of reach of children.

 **WARNING: Do not ingest the battery, chemical Burn Hazard.**

This product contains coin/button cell battery. If the coin/button cell battery is swallowed, it can cause severe internal burns in just 2 hours and can lead to death. Keep new and used batteries away from children. If the battery compartment does not close securely, stop using the product and keep it away from children. If you think batteries might have been swallowed or placed inside any part of the body, seek immediate medical attention.

#### WARNING



# Before You Drive

To renew the battery, following procedures must be observed:

## Replace the battery in remote key

- 1 Extend the mechanical key portion;
- 2 Pry the battery cover off the key body (with a RMB 1 coin);
- 3 Remove the used battery and install a new one;

**Note: Batteries of type CR2032 are recommended.**

### Caution

Pay attention to the positive and negative of battery.

- 4 Install the battery cover onto the key body.

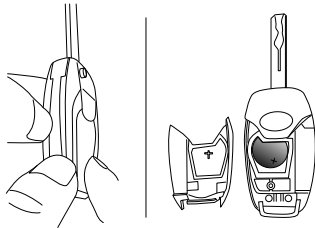

## Door locks

### To protect your vehicle against theft

**!** If leaving the vehicle with occupants inside, even briefly, always remove the key from the ignition lock, particularly if children remain in the vehicle. They could otherwise start the vehicle or operate electrical equipment at the risk of causing an accident.

Before leaving the vehicle, fully close all windows. Ensure all doors are fully closed before locking them.

### Locking/unlocking

The remote key can be used to lock/unlock the vehicle from the outside (electrically controlled door locking/unlocking). The ordinary key and the mechanical key portion of a remote key can only lock the driver's door and the tail gate from the outside, while the other doors could be locked from the outside (mechanical locking/unlocking) through the emergency lock of the lock body.

All doors can be locked/unlocked from the outside using the ordinary key or the remote key. All doors can be locked/unlocked from the inside using central lock switch. All doors can be automatically locked according to the vehicle speed.

**Note: All turn signal lights will flash once and the horn will sound once to indicate successful locking with remote key. All turn signal lights will flash twice to indicate successful unlocking with remote key.**

## Central door locking system

### Using ordinary key or mechanical key portion

All doors can be locked/unlocked using ordinary key or mechanical key portion to manually lock/unlock the driver's door from the outside.

To lock, turn the ordinary key or mechanical key portion clockwise.

To unlock, turn the ordinary key or mechanical key portion anti-clockwise.

### Using remote key

The doors can be locked/unlocked through the central door locking system using the buttons on the remote key.

**Note:** All doors must be fully closed for the system to operate correctly.

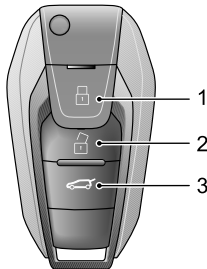

- 1 Central locking button
- 2 Central unlocking button
- 3 Tail gate unlocking button

### All doors locking

Press button (1) to lock all doors when all doors are closed.

**Note:** If all turn signal lights flash once, it indicates that locking has been confirmed. If any door is not fully closed, there will be no audible warning. Press button (1) only after all doors have been closed.

### All doors unlocking

Press button (2) to unlock all doors.

**Note:** If no door is opened within 30 seconds, all doors will be automatically locked again.

### Tail gate button

Long press button (3) for 2s to unlock the tail gate.

### Using central control door lock switch

All door can be unlocked or locked from the inside using the switch. Press the LOCK button to lock all doors. Press the UNLOCK button to unlock all doors.

**Note:** If driver's door is not closed, the lock motor will not operate. If any other door is not closed, the lock motor will operate.

## Before You Drive

---

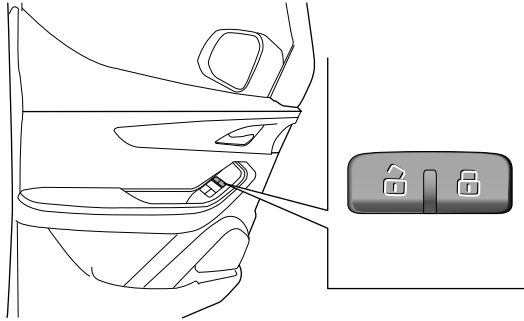

The door can also be unlocked by pulling the inner handle twice.

**Note: During the driving, all doors shall be fully closed and all door locks shall be enabled, so as to avoid accidental opening of doors.**

### Locking according to vehicle speed

When the vehicle speed exceeds 8 km/h, all doors can be locked automatically.

**Note: When the key is turned to 'LOCK' position, remove the key, and the doors will be automatically unlocked.**

## Manual unlocking/locking of doors

### Driver's door (from the inside)

To lock, close the door and press the button.

To unlock, lift the button. To open the door from the inside, pull the handle.

**Note: During the driving, all doors shall be fully closed and all door locks shall be enabled, so as to avoid accidental opening of doors.**

### Front occupant door (from the inside)

The unlocking/locking from the inside of the front occupant door are the same with those of the driver's door.

### Side loading door(s)

#### Opening/closing the door from the outside

To open the door from the outside, pull the handle and slide the door rearwards.

To close the door from the outside, pull the handle and slide the door forwards till it is fully closed.



# Before You Drive

---

## Lift tailgate

### **Unlocking/Opening outside the vehicle**

When using the ordinary key, remote key or central door lock control switch to lock or unlock all doors, the tailgate is also locked or unlocked.

If the tailgate is unlocked, it can be opened by flipping the tailgate handle (1) outward and pulling it upwards.

**Note: The tailgate swings upwards to open. When opening the tailgate, make sure there are no objects or people near the rear of the vehicle.**

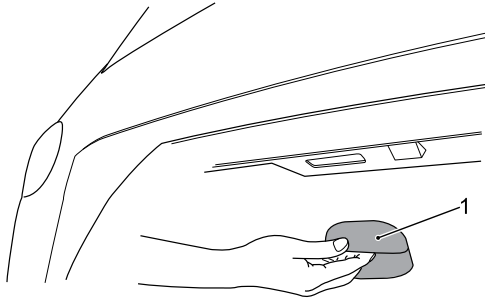

### **Locking/Closing outside the vehicle**

To close the tailgate, lower it and firmly press it down. Ensure that the tailgate is securely locked.

**Note: Make sure the tailgate is closed before driving the vehicle. If driving the vehicle without closing the tailgate, it may cause damage to the tailgate air pressure lift and other components.**

1

## Before You Drive

---

### Rear split-door

#### *Unlocking/Opening outside the vehicle*

Rotate the key or key head clockwise when manually unlocking/opening the tailgate outside the vehicle with the key.

After unlock the left door with the key, pull up the exterior door handle of the left door and open the left door first. The exterior door handle of the left door is located under the license plate lamp trim panel.

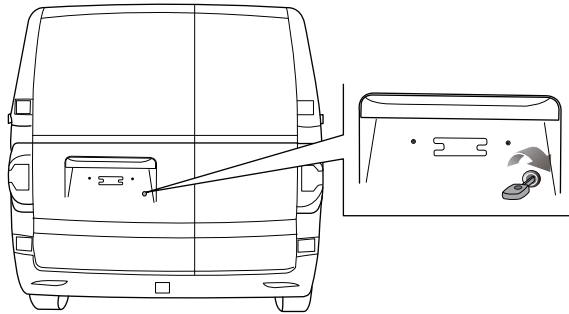

Then pull backward the handle on the right door side to open the right door.

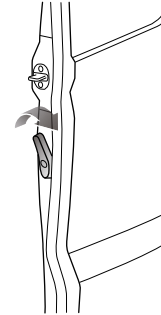

#### *Locking/Closing outside the vehicle*

Close the right door first when closing and locking the tailgate outside the vehicle. Push the right door to close and then close the left door, and counterclockwise rotate the key or key head to lock the tailgate.

## Unlocking/Opening inside the vehicle

When unlocking and opening the tailgate inside the vehicle, pull the interior door handle (1) on the inner side of the left door towards the left to unlock and open the left door. Then move the handle (2) on the right door side to unlock and open the right door.

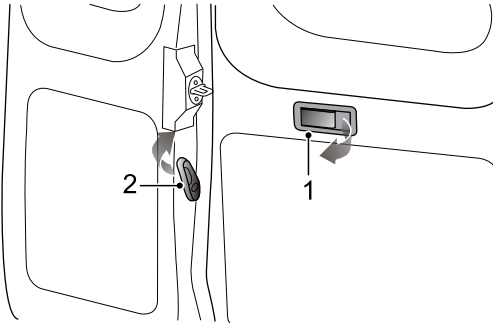

## Tailgate opening

The tailgate hinge has the position-limit function. The opening angle varies with different configuration and opening of the tailgate. The opening angle of the tailgate is subject to the actual vehicle configuration you purchased.

**!** When the tailgate is opening with a strong wind, the tailgate may swing, which may cause damage to pedestrians passing on the road, other road users or vehicles.

Do not open the tailgate to the max. opening, otherwise it may interfere with the traffic or cause damage to pedestrians.

In some cases, use of the tailgate may affect the warming effect of the rear combination lamp. When using the tailgate if it is dark, it is suggested to use additional warning signs (such as the highlight reflective triangle warning sign or similar device) to warn other vehicles or pedestrians.

When closing the tailgate, please close the right door first, and close the left one. Do not close the left and right doors at the same time to avoid damage to the top of the tailgate.

# Before You Drive

## Windows

**!** It is dangerous to leave children, incapacitated adults or pets in the vehicle with windows closed. They may faint out due to high temperature, or suffer permanent injury or even death due to heat stroke. Do not leave children, incapacitated adults or pets in the vehicle, especially in the warm or hot weather, with the windows closed.

## Power windows

**!** Always take care when operating the power window. There is a risk of injury, especially for the children. Please pay close attention when closing the window. Ensure that no objects are stuck in it while the window is moving.

### Driver's door window

There are 2 window switches on the driver's door. These two switches are respectively used to control the driver's door window and the front occupant door window. Press the front of the switch to open the window; lift the front of the switch to close the window.

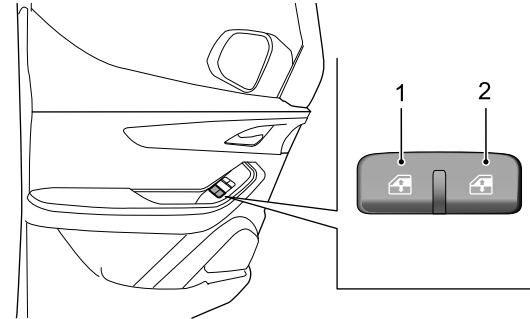

- 1 Driver's door window control switch
- 2 Front occupant door window control switch

### ***One-touch down function of driver's door window***

Your vehicle may be equipped with one-touch down function. Switch (1) has 2 gears: auto down and stroke down, so it can conveniently control the window glass down process. Briefly press the switch (1) down to the second gear, and the window glass will automatically move down.

### ***Resume auto down function***

If the battery cable is re-connected after disconnection, or the battery was drained, the auto down function may not work; a re-learning is necessary to resume the function.

# Before You Drive

Close all doors, press and hold the switch (1) till the window is fully open; keep holding the switch for several seconds, then the auto down function resumes.

## Front occupant door window

There is only 1 window switch on the front occupant door for controlling front occupant door window only. Press the front of the switch to open the window; lift the front of the switch to close the window.

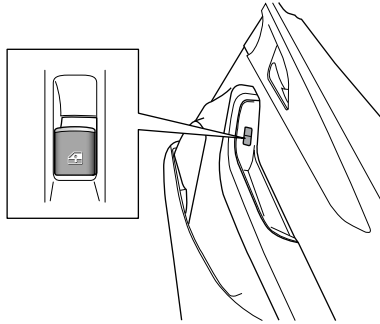

**Note:** The power windows will only operate when the power switch is turned to 'ON'.

## Seats

### Driver and front occupant seat adjustment

**!** Do not carry out driver's seat adjustment while the vehicle is moving. Otherwise control of the vehicle may be lost, causing an accident.

### Manually adjusted driver's seat



### Rake adjustment of backrest

**!** Do not recline the driver's seat excessively as the seat belt provides maximum protection when the angle between the backrest and the upright position is near 25°.

## Before You Drive

---

Slightly recline forward and pull the adjuster (1) backward; the seat backrest rebounds automatically. Then lean against the backrest to adjust it to the desired angle. Release the adjuster (1) and check that the seat back is locked in position.

### **Fore and aft**

Lift the bar (2), and slide the seat to the desired position. Release the bar (2) and check that the seat is locked in position.

### **Manually adjusted front occupant seat**

Only seat backrest adjustment can be made, and its adjustment is consistent with that of manually adjusted driver's seat.

### **Seat heater (if equipped)**

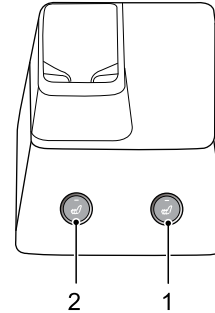

1 Driver seat heater switch

2 Front passenger seat heater switch

The seat heater switches are located on the auxiliary fascia console.

Press the driver seat heater switch (1) to electrically heat the driver seat.

Press the front passenger seat heater switch (2) to electrically heat the front passenger seat.

**Note: When the vehicle is not started, i.e., the “READY indicator (green)” on the instrument cluster does not illuminate, the seat heating function is not available.**

## Headrest

**!** To reduce the risk of neck or head injury, the headrest should be adjusted to support the back of the head and not the neck. Do not adjust the headrest while the vehicle is in motion.

Press the arrowed button to push down or pull up the headrest to adjust the headrest to the desired position.

When pulling to a proper position, the headrest can be pulled out.

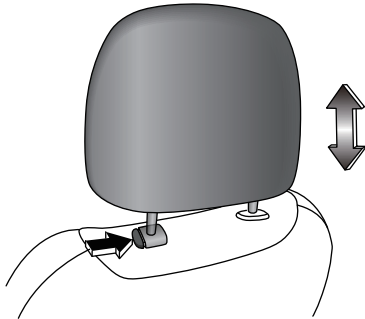

## Occupant restraint system

### Sitting correctly

The seat and its occupant restraint system have been designed to reduce personal injury to a minimum in the event of an accident. For optimum effectiveness, the following points should be observed.

- Do not position the seat nearer to the steering wheel than is necessary.
- Do not over-recline the seat. Adjust the rake of the backrest to no more than 30° angle so that you sit in an upright position with your arms slightly bent, and the base of your spine as far back as possible.
- Your headrest should be adjusted so that its center is level with the back of your head, not your neck.
- Diagonal belt should lie across the center of your shoulder.

# Before You Drive

---

## Seat belt

 Improperly worn or improper use of seat belts can cause serious injury or death. Seat belts are life saving equipment. In a collision, unrestrained occupants can be thrown around inside the vehicle or possibly thrown out, resulting in injury to themselves and also to other occupants.

Seat belts must be used at all times by the driver and adult sized occupants. Do NOT slacken the webbing by pulling the belt away from the body. To be fully effective the webbing must remain tightly around the body at all times. Avoid wearing thick, bulky clothing.

Never use a seat belt for more than one person, and never use it to secure an additional object or a child. Each seat belt can only be used by one occupant. It's dangerous to wrap a seat belt around a child in the occupant arms.

When wearing a seat belt ensure that the webbing is not twisted or slack. Otherwise the smooth operation of the belt may be impeded. The buckle release button must face outwards.

Do not allow a baby or infant to be carried on the lap. The force of a crash can increase effective body weight, making it impossible to hold onto the child.

 Do not allow foreign matter (particularly sugary food and drinks) to enter the seat belt buckles - such substances can render the buckles inoperative.

If the seat belt has been used in a serious accident, or shows serious wear, or has been cut, or the visual load meter shows that the seat belt is no longer available, the seat belt assembly must be replaced.

Pregnant women should ask their doctor for advice about the safest way to wear seat belts.

A seat belt must not be altered or modified in any way, since such changes may render the belt ineffective. Do not attempt to dismantle, repair or lubricate retractor or buckle mechanisms.

Always ensure correct storage of belts when not in use.

Be careful to avoid the erosion of webbing by polishing agents, oils and chemicals (especially battery acid). It can be cleaned safely with a mild soap and water. After wear, erosion or damage of the webbing occurs, the seat belt assembly should be replaced.

This series of vehicle are equipped with hip-shoulder belts, and this type of belt is the unadjustable seat belt with pretensioner.

 When the locking tab is pushed into the buckle, the seat belt is locked until a clear "clicks" is heard.



## Unadjustable seat belt with pretensioner

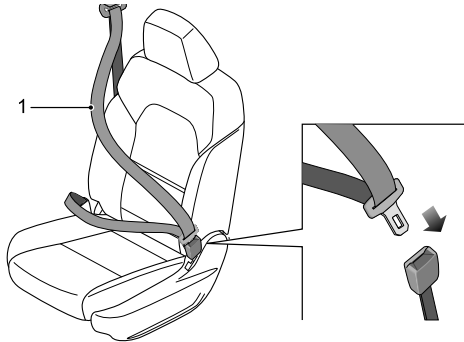

### ***Fastening***

The seat belt is pulled out of the scroll smoothly, passes through the shoulder to be fastened in front of the body, verify that the belt is not twisted or tied, then push the locking tab into the buckle.

### ***Loosening***

Press the red button on the buckle, then the locking tab will pop out under the action of the elastic force. Push the locking tab back manually, so that the automatic seat belt retractor can contract the whole seat belt more easily.

In the event of serious collision accident, the pretensioner (integrated into the retractor) will be activated by the sensor, the shoulder belt (1) will be contracted a little immediately to prevent

the occupants from moving forward and make them seated securely, so that it improves the function of the seat belt further.

### Caution

It may lock if pulled sharply or if the vehicle is on a slope.

1

### Seat Belt Warning Lamp

Please refer to "Warning Lamps and Indicators" in this section for more details about the seat belt warning lamp.

### Seat Belt Pretensioner

**!** Do not damage or repair the pretensioner. As it contains the ignition device, so it can only be repaired by our Service Dealer.

**The pretensioner will be invalid once being activated, so it must be replaced. Ensure that Service Dealer has checked and repaired the pretensioners and all seat belt components after the collision.**

The seat belt pretensioner works with the airbag to reduce the risk of injury caused by the frontal impact. Refer to the "Airbag" in this chapter for more information.

## Before You Drive

---

### Airbag(s)



No safety system can provide complete protection for personal injury or death in a severe crash. Injuries or death can occur, even if seat belts are worn properly and the airbags inflate.

After inflation some airbag components are hot - Do NOT touch until they have cooled.

An airbag inflates with considerable force and can cause facial abrasions and other injuries. These effects can be minimized by ensuring that you and your occupant(s) are wearing seat belts.

The driver's seat should be adjusted to be as far rearwards as possible while maintaining proper control of the vehicle.

Always hold the steering wheel by its rim, so that the airbag can inflate without obstruction.

Never attach accessory items e.g. a mobile phone bracket, cup holder, cassette tray, etc., or stick anything to an airbag module cover on the steering wheel cover or the fascia. It could interfere with inflation of the airbag or, if the airbag inflates, be propelled into the vehicle to cause injury to occupants.

Do not allow an occupant to obstruct the deployment of the airbag by putting feet, knees, etc. in contact with, or in close proximity to the airbag module cover.



The seat belt pretensioner works together with the airbag to reduce the risk of injury in the event of a head-on collision.

Do not attempt to remove or pierce the steering wheel, or hit it violently.

Do not allow another person, animal or object to occupy the space between the driver and the deploying range of the airbag. The same applies on the occupant side if an airbag is installed.

Do not attempt to repair or tamper with the steering wheel, steering column, any airbag system, pretensioner component or with wiring in the vicinity of an air bag component. It could cause inadvertent activation of the system resulting in personal injury.

Do not modify the front of the vehicle in any way as this could adversely affect airbag deployment.

If the vehicle is to be scrapped, undeployed airbags are potentially dangerous and should be deployed in a controlled environment. This operation must be done by professional staff.

This model can be equipped with the driver airbag, the front occupant airbag and front row side airbag.

**Note:** *Both the airbag and the pretensioner are supplementary protection device, while the seat belt is*

# Before You Drive

**still the main protection device and must be worn during driving.**

## Caution

- When an airbag is triggered a loud noise may be heard and a small amount of smoke-like gas and dust will be released. This smoke does not constitute a health hazard. The dust may be an irritant to the skin and therefore should be washed off with soap and water.
- For safety reasons you are recommended to have the airbag(s) renewed by our Service Dealer every 10 years. If the vehicle is sold, its owner is obliged to notify the purchaser of the cautions and warnings listed.

## Airbag and pretensioner inspection



**If the power switch is turned on, the warning light is not turned on or not turned off after several seconds, or turned on when driving, it indicates that the airbag pretensioner or the airbag is faulty. Please contact our Service Dealer for repair as soon as possible.**



As a system check, the "airbag warning light (red)" will flash for about several seconds each time the power switch is turned to position 'ON'.

## Airbag deployment

In case of crash, airbag control unit will detect deceleration or acceleration caused by crash to determine airbag deployment. Airbag will work based on the crash object, direction and vehicle deceleration rather than vehicle speed. Damage severity of vehicle shall not be considered as the judgment of airbag deployment. Airbag will deploy instantaneously and powerfully with loud noise. The deployed airbag and seatbelt restraint system could restrain driver and passenger from moving, reducing the risk of injury to the head and body. Upon deployment, the airbag will shrink immediately to ensure the driver could look forward without block.

**Note: Never touch the hot airbag parts after deployment until such parts get cooled.**

## Replace airbag system components after a collision accident



**The airbag system could be damaged due to the collision accident thus cannot operate normally to protect you and passengers in future accidents. This will result in serious injury even death. To ensure the airbag system remains valid after the collision accident, consult our Service Dealer to make necessary replacement of components.**

## Before You Drive

---

Once the airbag inflates, it is required to replace the components of the airbag system. Contact our Service Dealer for service as soon as possible.

### Child restraints (not supplied with the vehicle)



**DEATH or SERIOUS INJURY may occur! Children 12 and under can be killed by the airbag. NEVER use a child or infant restraint that faces backward on the front seat and the expanded airbag will cause serious child or infant injury and even death. Sit as far back as possible from the airbag.**

**NEVER use a rearward facing child restraint on a seat protected by an ACTIVE AIRBAG in front of it, DEATH or SERIOUS INJURY to the CHILD can occur!**

**Warning: Child restraint anchorages are designed to withstand only those loads imposed by correctly fitted child restraints. Under no circumstances are they to be used for adult seatbelts, harnesses, or for attaching other items or equipment to the vehicle.**

**When fitting and using a child restraint, always follow the manufacturer's instructions.**

Usually, infants under 2 years old shall use a infant restraint and children under 2 ~ 4 years old shall use the child restraint. Infant or child restraints are available in the market.

Because there are various size and types of infant or children restraints, you are recommended to choose the suitable

protection device depending on the infant's or children's age and weight to achieve the best protection. At the same time, you should check that the restraint is suitable for your vehicle as well.

#### Caution

In the case the infant or child restraint shall be positioned on the front seat while the vehicle is in motion, the infant or child restraint must face forward. Ensure properly secure the infant or child restraint. Note that an unsecured infant or child restraint may move and run into other occupants when any crash or heavy braking occurs. Even if there is no infant or child, any infant or child restraint shall be properly secured in the vehicle.

# Before You Drive

## Instruments and controls

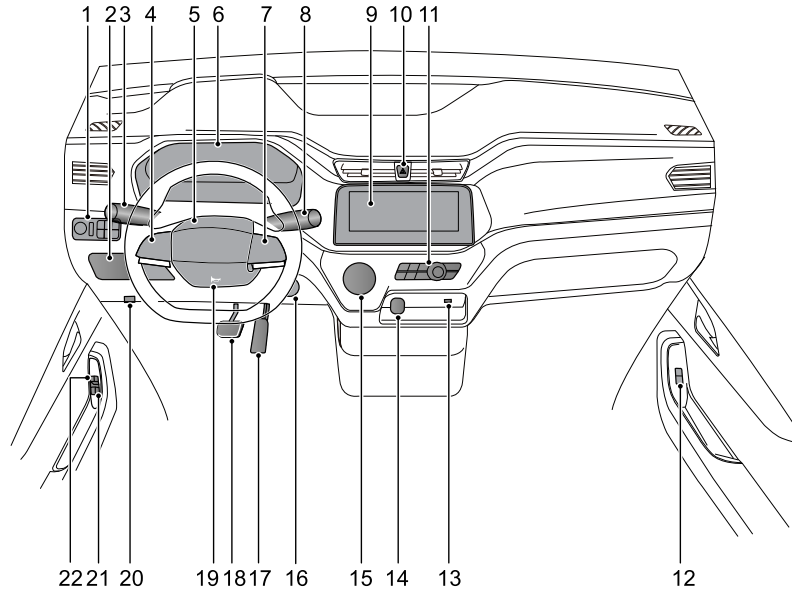

- 1 Headlamp leveling switch  
Exterior rear view mirror power adjustment switch  
ESP OFF, AVAS, ECO, REG, Heated rearview mirrors switches
- 2 Storage compartment
- 3 Lighting and direction indicator lever switch
- 4 Cruise switch
- 5 Driver airbag
- 6 Instrument cluster
- 7 Voice control and bluetooth phone switch
- 8 Wiper and washer lever switch
- 9 Entertainment system
- 10 Hazard light switch
- 11 A/C control panel
- 12 Front occupant door window control switch
- 13 USB port
- 14 12V power outlet
- 15 Shift knob
- 16 Power switch
- 17 Accelerator pedal
- 18 Brake pedal
- 19 Horn
- 20 Front compartment hood release handle
- 21 Driver and front occupant door window control switch
- 22 Central control door lock switch

# Before You Drive

## Instrument cluster

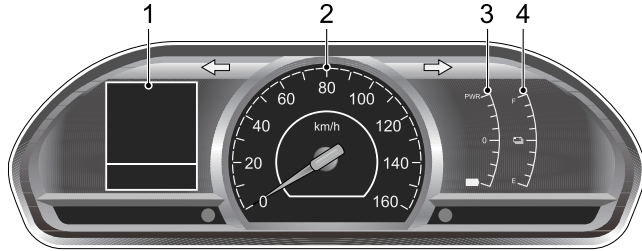

- 1 Information center
- 2 Speedometer
- 3 Drive motor power percentage table
- 4 Voltmeter of high-voltage battery pack

### Caution

Don't place any object in the front of the instrument cluster to avoid shielding dial and warning light.

## Speedometer

The speedometer displays the current road speed in kilometers per hour.

## Drive motor power percentage table

Displays the power percentage of the power system.

A value below zero represents a negative percentage; a value above zero represents a positive percentage.

If the drive motor power percentage is displayed as a positive value, it means that the power system outputs power to drive the vehicle; if the drive motor power percentage is displayed as a negative value, it means that some of the kinetic energy of the power system is converted into electric energy.

## Voltmeter of high-voltage battery pack

The state of voltmeter of high-voltage battery pack will be indicated based on quantity of ignited strip-type bar.

When the battery is low, the red strip-type bar will be lit, and the "high-voltage battery pack low battery warning light (yellow)" will also be lit.

**Note:** A low high-voltage battery pack will make some functions of the vehicle lose effect.

### Caution

When the high-voltage battery pack is low, the battery will be charged as soon as possible. Ensure enough power is stored in the high-voltage battery pack before running. Once the battery is fully charged, the battery management system will have an automatic calibration function. If the vehicle has been shallowly charged (less than 99%) every two or three times, you need to fully charge (100%) the vehicle once.

# Before You Drive

## Information center

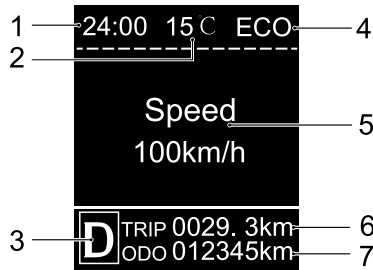

When there is no alarm message, the upper part of the display can show clock, Outside Temperature, Driving Mode, trip computer interface, individual journey (TRIP), total distance (ODO), gear position display information.

### 1 Clock

**Note:** It is applicable to the vehicle equipped with the clock display.

### 2 Outside temperature

**Note:** It is applicable to the vehicle equipped with the outside temperature display.

### 3 Gear

### 4 Driving mode

### 5 Trip computer interface

### 6 Individual journey (TRIP)

### 7 Total distance (ODO)

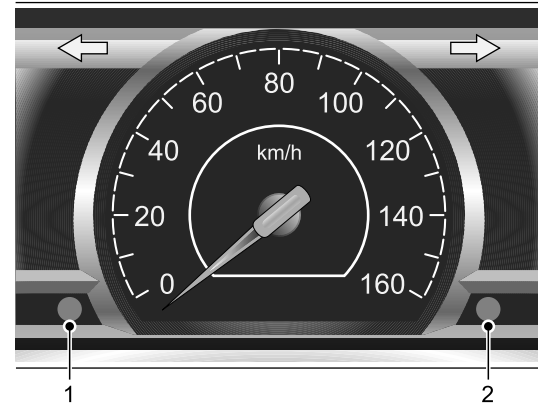

## Clock

**Note:** It is applicable to the vehicle equipped with the clock display.

In hrs/min (at the uppermost of the display).

Clock setting (effective only when radio is configured):

Press and hold (2) (above 2 sec) to enter the clock setting mode when the clock figure will flash. Short press (2) (less than 1 sec) to set the hour value. Every short press increases the hour value by one hour (0 ~ 24 hours).

# Before You Drive

---

In the time setting mode, no short press (2) (less than 1 sec) or long press (2) (above 2 sec) within 5 seconds to enter the minute setting mode when the minute figure will flash. Short press (2) (less than 1 sec) to set the minute value. Every short press increases the minute value by one minute (0 ~ 60 minutes). (If the minute value is over 60, the hour value will not be affected).

In the minute setting mode, no press (2) within 5 seconds to exit the clock setting mode.

**Note: If the battery is disconnected, the time should be reset.**

**Note: For vehicles equipped with a large entertainment system display, the clocks of the instrument cluster and the entertainment system are automatically synchronized.**

## Trip computer interface

Short press (1) (less than 1 sec) to switch over as per interfaces of driving range, drive motor speed, voltage of power battery, current of power battery, vehicle speed, instantaneous power consumption, average power consumption and residual capacity.

- Driving range

It refers to the range that can be driven before electric quantity of the high-voltage battery pack is used out.

**Note: Driving range is related to running condition, vehicle state, accessory to use, etc. When the battery is low, driving range is just for reference.**

- Drive motor speed

Displays current drive motor speed.

- Voltage of power battery

Displays current voltage of power battery.

- Current of power battery

Displays present current of power battery.

- Speed

Displays current speed.

- Instantaneous power consumption

Displays current power consumption.

- Average power consumption

Displays power consumption per 100 km.

- Residual capacity

Displays the percentage of power remaining in the high-voltage battery pack. If the battery is too low, please charge immediately to avoid affecting normal driving.

## Individual journey (TRIP)

Displays the distance traveled after the last setting.

Individual journey reset:

Short press (2) (less than 1 sec) to clear the currently displayed individual journey. The clear times are not limited.

## Total distance (ODO)

Displays total distance traveled.



**Note:** *The total distance cannot be cleared.*

## **Alarm information interface**

### **Long-distance limp alarm interface**

- Lease expires; enter Limp mode
- Communication interrupts; enter Limp mode

**Note:** *After entering the Limp mode, the vehicle can only be driven at a speed of 5 to 10 km/h. Please conduct annual inspection or return the vehicle as soon as possible.*

### **Maintenance alarm interface**

- Imminent maintenance, please arrange maintenance
- Maintenance overdue, please maintain your vehicle immediately

**Note:** *When the maintenance reminder appears in the information center, please go to our Service Dealer for maintenance immediately.*

### **Other alarm interfaces**

- Key in ignition
- Position lights on
- Drive motor over-speed
- Drive motor running
- Overspeed alarm
- Release the handbrake

## **Display brightness adjustment**

When the power switch is turned to position 'ON', press (1) to adjust the brightness of the display illumination. Press and hold (1) (above 2 sec) to make it gradually dimmed and return to a higher brightness when lowest is reached.

**Note:** *The lowest state is not unlit.*

# Before You Drive

---

## Warning lights and indicators

### Direction indicator



During steering, the "direction indicator (green)" at left or right side flashes on the instrument cluster. When the hazard light switch is pressed, the left and right direction indicators flash simultaneously.

**Note:** *If a direction indicator flashes rapidly, it indicates that the bulb in this direction indicator is faulty.*

### Headlamp main beam indicator



The "headlamp main beam indicator (blue)" on the instrument cluster will come on when the headlamps are on main beam or flash on.

### Rear fog light indicator



The "rear fog light indicator (yellow)" on the instrument cluster illuminates whenever the rear fog lights are on.

### Position light indicator



The "position light indicator (green)" on the instrument cluster will come on when the position lights illuminate.

## Door open warning light



The "door open warning light (red)" on the instrument cluster will illuminate if any door is not fully closed. The "door open warning light (red)" will extinguish after all doors are fully closed.

## Seat belt warning light



As a system check, the "seat belt warning light (red)" on the instrument cluster will come on for several seconds when the power switch is turned to position 'ON'.

If the driver's seat belt is not fastened properly, the "seat belt warning light (red)" will illuminate; if the vehicle speed exceeds 20 km/h, an audible warning of seat belt not fastened will also sound, meanwhile the "seat belt warning light (red)" will flash. The "seat belt warning light (red)" will go out and the audible warning will extinguish when the seat belt is correctly fastened.

## Airbag warning light



As a system check, the "airbag warning light (red)" on the instrument cluster will come on for several seconds when the power switch is turned to position 'ON'.

If the light fails to come on or flash, or fails to go out, or if it comes on or flashes while driving, it means that there is a malfunction

in the system. Contact our Service Dealer for service as soon as possible.

For further information on the air bags, see "Airbag".

## Brake system warning light



As a system check, the "brake system warning light (red)" on the instrument cluster will come on for several seconds when the power switch is turned to position 'ON'.

If the "brake system warning light (red)" is still lit, or it is lit again when running, it means that the liquid level of braking fluid is below the normal range or that the brake system has fault, the vehicle shall be immediately parked and overhauled by contacting our Service Dealer as soon as possible.

## ABS (Anti-lock Braking System) warning light



As a system check, the "ABS warning light (yellow)" on the instrument cluster will come on for several seconds when the power switch is turned to position 'ON'.

If the ABS warning light fails to go out or illuminates again while driving, there is a fault in the ABS. You should contact our Service Dealer immediately.

**Note: The brake system can be used even if ABS is faulty (ABS failure). See "Brake system" for important information about ABS.**

## EBD (Electronic Brake Distribution) warning light



As a system check, the "EBD warning light (red)" on the instrument cluster will come on for several seconds when the power switch is turned to position 'ON'.

If the EBD warning light fails to go out or illuminates again while driving, there is a fault in the EBD. You should contact our Service Dealer immediately.

## ESP (Electronic Stability Program) indicator



When the power switch is turned to ON position, the "ESP indicator (yellow)" illuminates and goes out after several seconds.

The "ESP indicator (yellow)" flashes when the ESP operates normally while driving.

The "ESP indicator (yellow)" illuminates when the ESP breaks down.

Contact our Service Dealer for service as soon as possible. For further information about ESP, please see "Brake system" in Starting and Driving section.

## Before You Drive

---

### ESP (Electronic Stability Program) OFF indicator



When the power switch is turned to ON position, the "ESP OFF indicator (yellow)" illuminates and goes out after several seconds.

The "ESP OFF indicator (yellow)" illuminates when the ESP function is turned off by pressing the ESP OFF switch.

### Electric power steering fault warning light



As a system check, the "electric power steering fault warning light (red)" on the instrument cluster will come on for several seconds when the power switch is turned to position 'ON'. If the light fails to go out or illuminates again while driving, there is a fault in the EPS. You should contact our Service Dealer immediately.

### Drive motor overheat warning light



As a system check, the "drive motor overheat warning light (red)" on the instrument cluster will come on for several seconds when the power switch is turned to position 'ON'. When the temperature of the drive motor is high, this light will flash, and you should contact our Service Dealer for service as soon as possible.

### Power system fault warning light



As a system check, the "power system fault warning light (red)" on the instrument cluster will come on for several seconds when the power switch is turned to position 'ON'. When the power system breaks down, this light will be lit. You should contact our Service Dealer for service as soon as possible.

### High-voltage battery pack cutoff warning light



When the power switch is adjusted to position ON, the "high-voltage battery pack cutoff warning light (yellow)" on the instrument cluster will be lit, which means that the high-voltage battery pack has been cut off. This light will go out after the vehicle is started.

### High-voltage battery pack low battery warning light



As a system check, the "high-voltage battery pack low battery warning light (yellow)" on the instrument cluster will come on for several seconds when the power switch is turned to position 'ON'. If the light fails to go out or illuminates again while driving, the high-voltage battery pack is low and needs to be recharged as soon as possible. You'd better recharge the battery before this light is lit.

**Note:** *If the warning light is lit, it means that speed limit function of the vehicle has been started. Vehicle speed will be reduced with decrease of electric quantity of the battery until it is stopped.*

## High-voltage battery pack fault warning light



As a system check, the "high-voltage battery pack fault warning light (red)" on the instrument cluster will come on for several seconds when the power switch is turned to position 'ON'. If the light fails to go out or illuminates again while driving, there is a fault in the high-voltage battery pack.

## Charging connection indicator



After the charging connector is connected to the charging port, the "charging connection indicator (red)" on the instrument cluster will be lit.

## Charging status indicator



When the high-voltage battery pack is being charged, the "charging status indicator (yellow)" on the instrument cluster will flash. When the high-voltage battery pack has been charged, this indicator will go out.

When the high-voltage battery pack is being heated, the "charging status indicator (yellow)" on the instrument cluster

will flash(0.5Hz). When the high-voltage battery pack has been heated, this indicator will turn to flash, which means to be charged.

When the high-voltage battery pack is being charge status, the "charging status indicator (yellow)" on the instrument cluster will be always on, but the current is 0A.

**Note:** *If the "charging status indicator (yellow)" extinguishes, which is not due to active stop charging by a person or fully charged, it indicates that the battery is faulty and cannot be charged. Contact our Service Dealer for service as soon as possible.*

## READY indicator



This light is used to indicate that the vehicle is ready for running. After the vehicle is started, the "READY indicator (green)" on the instrument cluster will be lit. This light will not go out in the running process.

### Caution

Before the "READY indicator (green)" is lit, switch of air conditioning will be pressed, and air conditioning compressor will not work. Before the "READY indicator (green)" is lit, control knob of air blower will not be started and the headlamp and radio cannot be used for long time, as it will cause risk that the vehicle cannot be started.

# Before You Drive

## Battery charging indicator



As a system check, the "battery charging indicator (red)" on the instrument cluster will come on for several seconds when the power switch is turned to position 'ON'.

### Caution

If the warning light fails to go out after the vehicle is started or illuminates while driving, there is a fault in the charging system. You should contact our Service Dealer for service as soon as possible.

## Insulation fault warning light



As a system check, the "insulation fault warning light (red)" on the instrument cluster will come on for several seconds when the power switch is turned to position 'ON'. If the light fails to go out or illuminates again while driving, it indicates an insulation fault.

## Limited power indicator



In normal driving state, the "limited power indicator (yellow)" on the instrument cluster keeps off. When the "limited power indicator (yellow)" illuminates, the power of the vehicle will be limited and the acceleration performance will be significantly

weakened. Contact our Service Dealer for service as soon as possible.

## Cruise control indicator



With the power switch in ON position, if the cruise system is on standby, the "cruise control indicator (white)" illuminates; if the cruise system is active, the "cruise control indicator (green)" illuminates. See "Cruise control system" in Starting and Driving section for more information.

## TPMS warning light



When the power switch is turned to ON position, the "TPMS warning light (yellow)" illuminates and goes out after several seconds. When the tire pressure monitoring system breaks down, the "TPMS warning light (yellow)" illuminates. Please contact our Service Dealer for service as soon as possible.

## FCW (Forward Collision Warning) warning light/AEB (Automatic Emergency Braking) warning light

**Note:** *It applies to vehicles configured with FCW and AEB.*



When the power switch is turned to ON position, if the FCW/AEB function is not enabled or is faulty, the "FCW/AEB

warning light (yellow)" illuminates; if the FCW/AEB function is enabled, the warning light will not illuminate. If the FCW system gives an alarm, the "FCW/AEB warning light (yellow)" flashes; if the AEB function is triggered, the "FCW/AEB warning light (red)" flashes.

See "FCW (Forward Collision Warning) and AEB (Automatic Emergency Braking)" in the Starting and Driving section for more description.

### **LDW (Lane Departure Warning)/LKA (Lane Keep Assist) /ELK (Emergency Lane Keeping) warning light**

**Note: It applies to the vehicles with LDW, LKA and ELK.**



When the power switch is turned to ON position, when LDW, LKA and ELK are operating, the "LDW warning light/LKA warning light /ELK warning light (grey)" illuminates.

When LDW, LKA and ELK give an alarm or are triggered, the "LDW warning light/LKA warning light /ELK warning light (yellow)" flashes.

When LDW, LKA and ELK are disabled, the "LDW warning light/LKA warning light /ELK warning light (yellow)" illuminates.

If the warning light illuminates in yellow when LDW, LKA and ELK are enabled, it indicates that the LDW, LKA and ELK break down. Please contact Our Service Dealer for service as soon as possible.

See "LDW (Lane Departure Warning)/LKA (Lane Keep Assist) /ELK (Emergency Lane Keeping)" in the Starting and Driving section for more description of their functions.

### **SLIF (Speed Limit Information Function) indicators**

**Note: It applies to vehicles configured with SLIF system.**



When the power switch is turned to ON position, when a traffic sign is detected, the "SLIF indicator" illuminates. See "SLIF (Speed Limit Information Function)" in the Starting and Driving section for more information.

# Before You Drive

## Instrument cluster switch

### Headlamp leveling switch

When the low beam is on, this headlamp leveling switch allows you to adjust the headlamp beam angle, to compensate for varying vehicle loads and minimize dazzling oncoming traffic.

0 position is the original position. As the vehicle loads increase, adjust the illuminating height according to the sequence of 1-2-3.

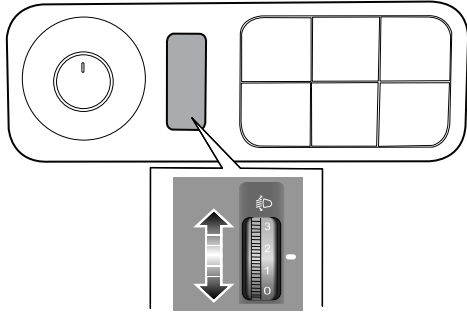

## ESP OFF switch

Turn the power switch to position ON, pressing the ESP OFF switch illuminates the indicator on it and turns off the ESP system. Pressing the switch again turns on the system. When ESP OFF is enabled, only ABS and EBD functions work. For more information, see “Brake System” in the Starting & Driving section.

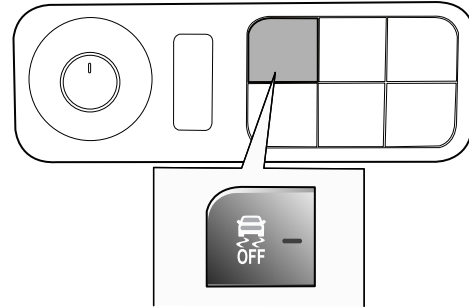



# Before You Drive

## AVAS switch

**Note:** *It is applicable to the vehicle equipped with the AVAS switch.*

Acoustic vehicle alerting system (AVAS) switch is located on the driver-side instrument desk. Pressing the AVAS switch illuminates the indicator on it and turns off the low-speed pedestrian alert function. For more information, see “Acoustic vehicle alerting system (AVAS)” in the Starting & Driving section.

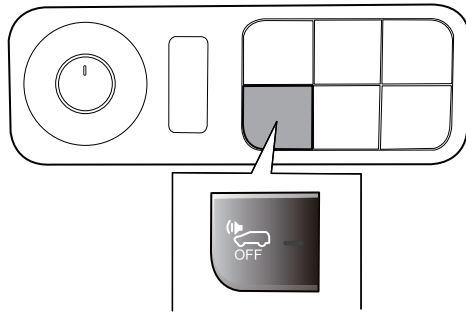

## ECO switch

Turn the power switch to position ON, and the initial state of the vehicle defaults to Normal. Pressing the ECO switch switches the driving mode to ECO and illuminates the “ECO indicator (green)” in the IPK. The energy recovery intensity of the vehicle in ECO mode is higher than that in Normal mode. Pressing the switch again switches the driving mode to Normal.

1

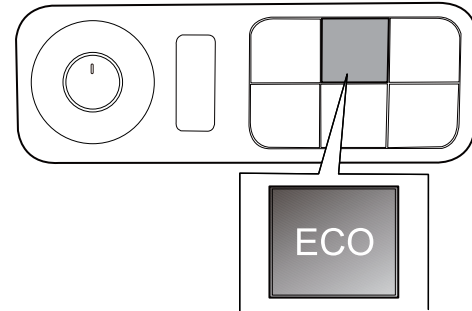

## Before You Drive

### REG switch

The REG switch can be used to switch the energy recovery mode among 3 modes: High, Moderate and Low; the default mode is Moderate. Turn the power switch to position ON, pressing the REG switch in turn switches modes in the following order: Moderate→High→Moderate→Low→Moderate, and that cycle repeats; meanwhile, the IPK displays 2→3→2→1→2. The higher the mode is, the higher the energy recovery efficiency will be.

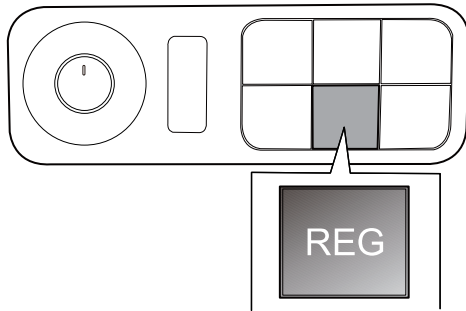

### Heated rearview mirrors switch

**Note: It is applicable to the vehicle equipped with the heated rearview mirrors switch.**

For vehicles equipped with heated rearview mirrors, press the heated rearview mirrors switch on the driver-side instrument desk to enable the exterior rearview mirror heating function.

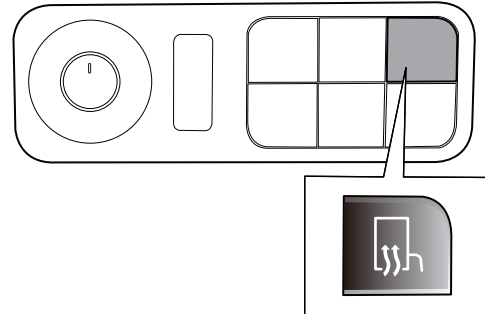

# Before You Drive

## Hazard light switch

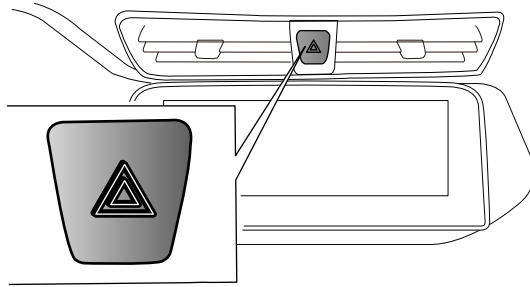

Press the hazard light switch  to activate all the turn signal lights simultaneously, and the "direction indicator (green)" on the instrument cluster will illuminate and flash. Press the switch again to turn off the above lights.

**Note:** Turn on the hazard lights to inform other road users that your vehicle has a malfunction and approaching may be dangerous.

## SOS alarm switch

**Note:** It is applicable to the vehicle equipped with the SOS alarm switch. 1

The SOS switch is located at the ceiling microphone. In case of an emergency, you may press the SOS alarm switch to send signals to the monitoring platform, and the platform can carry out the subsequent assistance work.

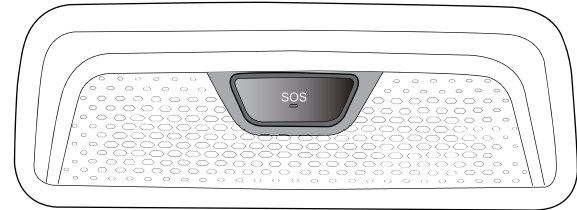

### Caution

This switch is for emergency use only, please do not operate it without permission.

# Before You Drive

## Switches on steering column and steering wheel

### Power switch and steering lock

When the key is removed, the steering lock will be activated and prevent the steering wheel from being turned.



To remove the key from the power switch, turn it anti-clockwise to position 'ACC (UNLOCK)'. Then press the key in towards the power switch and continue to turn anti-clockwise to position 'LOCK'. The key can now be removed.

**Note:** If the key is not removed from the power switch, an audible warning will sound when the driver's door is opened.

For more information on the position of the power switch see "Power switch".

## Combination light control & direction indicator lever switch

### Light control switch

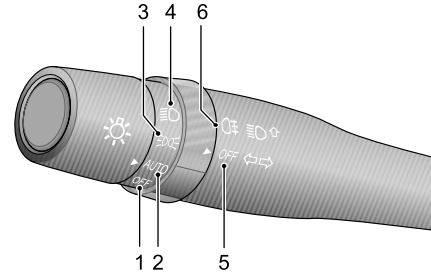

Rotate the light control switch to the positions shown, and the corresponding light illuminates.

Position 1 -OFF: headlamps off. Daytime running lights automatically illuminate after the motor is started.

Position 2 -AUTO: Headlamp automatic adjustment. When the headlamp switch is placed in AUTO position, headlamps will illuminate/go off according to the lighting brightness of ambient environment. Daytime running lamps will automatically illuminate when other lamps are not turned on after the engine is started.

Position 3 -ON: position lights on. When turning on the position lights, the following lights illuminate:





# Before You Drive

- Position lights
- License plate lights
- Instrument cluster lights

Position 4 : headlamps low beam on.

**Note: Headlamps will only operate when the power switch is in position 'ON'. If headlamps are on when the vehicle is parked, the battery will discharge and the vehicle may be unable to restart due to battery lack of power. A tone will sound if the headlamp switch is on when the power switch is turned to position 'LOCK' or when the key is removed.**

Position 5 -OFF: fog lights off.

Position 6 : rear fog lights on. When the power switch is in position 'ON' and the light control switch is in high beam or  low beam position, rotating the switch to  position turns the rear fog lights on. When the lighting control switch is placed in AUTO position, turn the switch to , and then rear fog lamps will illuminate or go off along with headlamps according to ambient environment. When the rear fog lamps are turned on, the "rear fog lamp indicator lamp (yellow)" on the instrument cluster will illuminate.

**Note: Rear fog lights shall not be used until the visibility is obviously restricted (such as heavy fog or snow).**

## Turn signal lights and direction indicators

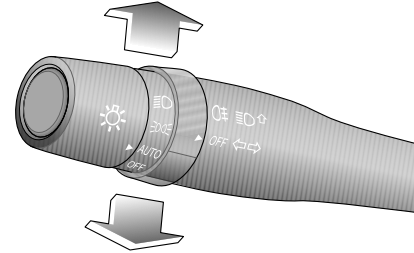

Right turn — push the lever switch upward.

Left turn — pull the lever switch downward.

The appropriate "direction indicator (green)" on the instrument cluster illuminate in time with the indicator lights.

## Headlamp high and low beams

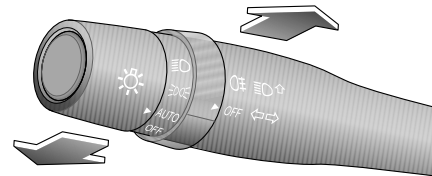

## Before You Drive

Push the lever switch away from the steering wheel to change the headlamps from low to high beam. Pull the lever switch towards the steering wheel to return to the low beam position.

**Note:** The "headlamp main beam indicator (blue)" on the instrument cluster illuminates when the headlamps are on main beam. To flash the headlamps, slightly lift the lever switch intermittently towards the steering wheel.

### Daytime running light

Daytime running lights make it easier for others to see the front of your vehicle clearly during the day.

If your vehicle is equipped with daytime running lights, the daytime running lights will illuminate when the power switch is in position 'ON'. The low beam, taillights, position lights, and other lights do not illuminate when the daytime running lights are on. When the power switch is in position 'OFF', the daytime running lights go out. Comply with ECE R87 regulatory requirements for daytime running lights.

## Wiper and washer lever switch

### Windshield wiper and washer

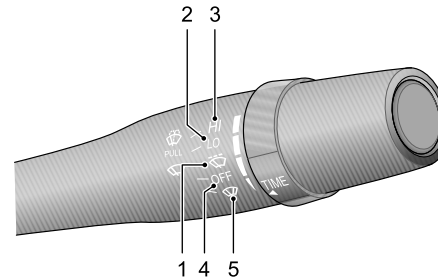

Move the lever switch to the desired position.

Position 1 - : intermittent wipe.

Position 2 -LO: low-speed wipe.

Position 3 -HI: high-speed wipe.

Position 4 -OFF: wiper off.

Position 5 - : single wipe.

# Before You Drive

## Intermittent wipe/variable delay

**⚠** Worn wiper blades may not clear the windshield properly, thus reducing forward visibility and be the cause of an accident. Always renew worn wiper blades immediately.

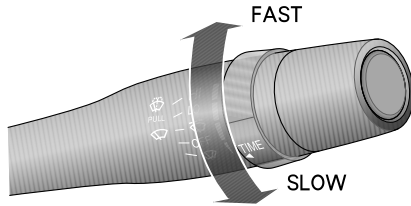

When the lever switch is in  (intermittent) position, rotate the switch to vary the delay between wipes.

### Caution

In freezing or very hot conditions, to prevent damage to the wipers, ensure the blades are not frozen or otherwise adhering to the glass, and clear the screen of obstructions such as snow. Do not operate wipers when the windshield is dry. It can scratch the glass, cause the blades to wear prematurely and obscure vision.

## Washers

Pull the lever switch towards the steering wheel. The washer will operate immediately. After a short interval, the wiper will operate with the washer. The washer will be off when the lever switch is released.

**Note:** The wipers will continue to operate for 3 wipes after the lever switch is released.

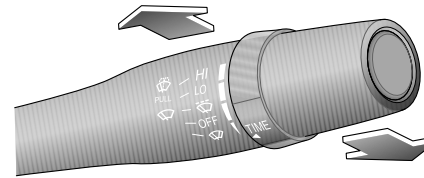

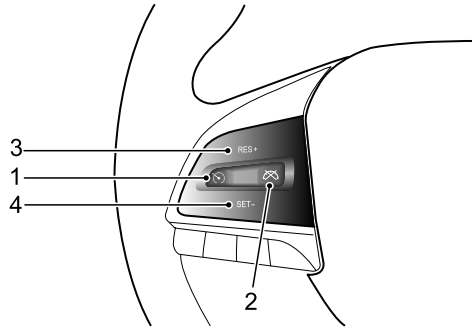

# Before You Drive

## Cruise switch



Position 1 - : cruise on/off switch. Press this switch to turn the cruise control system on or off. The "cruise control indicator" in the instrument cluster illuminates or goes out accordingly.

Position 2 - : cruise cancel switch. Press this switch to cancel the cruise control function without clearing the set speed in the memory.

Position 3 - RES+: cruise recovery/acceleration switch. If a set speed has been stored, press  upward to resume that speed; press upward again to accelerate (1 km/h per time).





Position 4 - SET-: cruise setting/deceleration switch. Press  downward to set a speed. Then the cruise control function will be enabled and the "cruise control indicator" in the instrument cluster will turn green from white. If the cruise

function is operating, press  downward to decelerate (1 km/h per time).

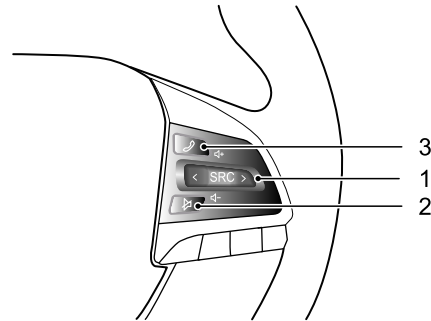
**Note:** See "Cruise control system" in Starting and Driving section for more descriptions about cruise control function.

## Voice control and bluetooth phone switch



Position 1 - : sound source control switch. Press SRC to switch the radio/music player interface; press upward to increase the volume and downward to decrease; short press  to switch to the previous band/music track; long press  to fast-backward; short press  to switch to the next band/music track; long press  to fast-forward.

Position 2 - : mute switch.



## Before You Drive

---

Position 3 - 📞: Bluetooth phone switch. When Bluetooth is connected, this switch is the Bluetooth phone answering switch. In the general calling state: when there is an incoming call, short press the switch to answer, and long press it to hang up; during the call, short press the switch to hang up, and long press it also to hang up; during the dialing, short press the switch to hang up, long press it also to hang up. During the call, if there is a call from a third party, short press the switch to hold the current call and answer the new call; long press it to hang up the new call and hold the original call. After the short-press, you can hang up the original call and answer the new call through the soft button on the entertainment system display.

### Horn

The horn can operate when the button is pressed, regardless of the power switch position.

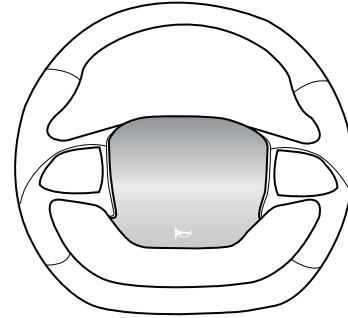

1

### Steering wheel adjustment

**!** Do not adjust the steering wheel position during driving. This is extremely dangerous.

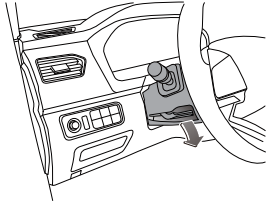

Adjust the steering wheel position to adapt to your driving posture through the following steps:

- 1 Fully release the steering wheel adjusting handle on the steering column downwards;
- 2 Grasp the steering wheel firmly with both hands, and move the steering wheel upwards or downwards to adjust it to a proper position;

***Note: If it is still difficult to move the steering wheel to a proper position, place the ignition switch in ON position to unlock the steering wheel, and turn the steering wheel to the straight forward position.***

- 3 Select a proper driving position, and pull the steering wheel adjusting handle fully up to lock the steering wheel into its new position.

### Heating, ventilation and air conditioning (HVAC)

The air conditioning system cools the air and removes moisture and dust e.g. pollen.

The heating system uses the high voltage electronic heater, which means the interior air can be heated only when the vehicle is connected to the high voltage power supply.

The ventilation system ensures the interior ventilation when the vehicle is moving.

The front A/C blower speed selection button is used to control the blower speed.

HVAC is used to control the interior air cooling, heating and ventilation. The fresh air enters the vehicle through the front windshield inlet grille via the AC filter. The inlet grille should keep clean, without obstructions like leaves, snow or ice.

# Before You Drive

## Front ventilation

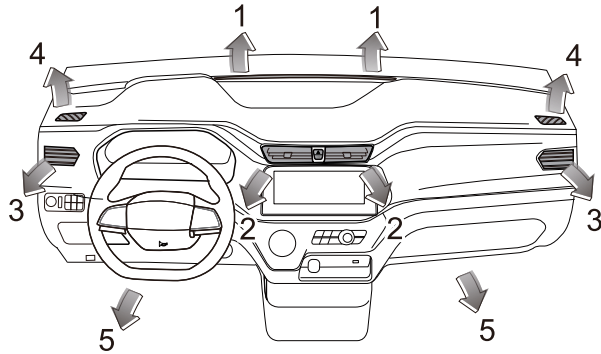

- 1 Windshield vents
- 2 Central vents
- 3 Side vents
- 4 Front door window vents
- 5 Front footwell vents

## Central vents

The direction of air flow can be changed by moving the plate (1) in the center of the grille upward, downward, leftward and rightward.

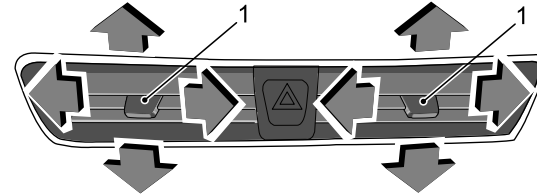

## Side vents

The direction of air flow can be changed by moving the plate in the center of the grille upward, downward, leftward and rightward.

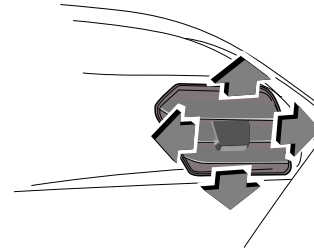

1

# Before You Drive

## Front manual AC control panel (heating & cooling)

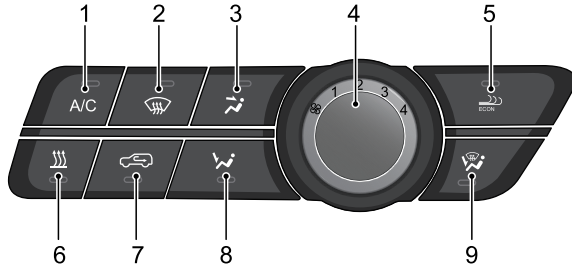

- 1 A/C button
- 2 Front defroster button
- 3 Air to the face mode button
- 4 Blower speed control knob
- 5 Comfort button
- 6 Heating button
- 7 Internal/external circulation button
- 8 Air to the foot mode button
- 9 Air to the foot & defroster button

### A/C button

Switch on and off the compressor. With the blower speed in 'non-0' position, pressing the A/C button illuminates the

corresponding indicator lamp; the air conditioner will cool the interior air and also remove moisture.

### Front defroster button

To turn on the front defroster. With the blower speed in 'non-0' position, pressing the front defroster button illuminates the corresponding indicator lamp as well as the A/C indicator; the air distribution mode is switched to Windshield mode.

### Air to the face mode button

Directs air to the face. With the blower speed in 'non-0' position, pressing the 'Air to the face' mode button illuminates the corresponding indicator lamp; the Air to the face mode is selected.

### Blower speed control knob

Switch on/off and adjust the blower speed. There are five positions for the blower speed control knob to switch between. The '0' position indicates that the blower is turned off. You can rotate the control knob clockwise from '0' position to '4' position to increase the blower speed in 1-position increments.

### Comfort button

Adjusts the interior temperature. In the cooling mode, press the Comfort button to halve the cooling capacity of the air conditioner to avoid too low temperature in the car; in the heating mode, press the Comfort button to halve the heating capacity of the air conditioner to avoid excessive temperature in the car.

# Before You Drive

## Heating button

Controls the heating button to turn on/off. With the blower speed in 'non-☼' position, pressing the heating button illuminates the corresponding indicator lamp; the air conditioner enters the air heating mode.

## Internal/external circulation button

To switch between internal and external circulation through the button. When the corresponding indicator is on, it indicates that it is in the internal circulation mode. When the button is pressed again, the corresponding indicator is off, indicating that it is in the external circulation mode.

## Air to the foot mode button

Directs air to the footwell. With the blower speed in 'non-☼' position, pressing the 'Air to the foot' mode button illuminates the corresponding indicator lamp; the Air to the foot mode is selected.

## Air to the foot & defrost mode button

Adjust the air distribution mode to 'Air to the foot & defroster'. With the blower speed in 'non-☼' position, pressing the 'Air to the foot & defroster' button illuminates the corresponding indicator lamp; the Air to the foot & windshield mode is selected.

## Front automatic AC control panel (heating & cooling)

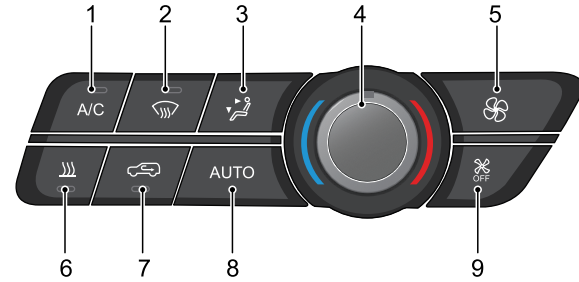

- 1 A/C button
- 2 Front defroster button
- 3 Mode button
- 4 Temperature control knob
- 5 Air volume increase button
- 6 Heating button
- 7 Internal/external circulation button
- 8 AUTO button
- 9 Air volume decrease/OFF button

## A/C button

Switch on and off the compressor.

# Before You Drive

---

When the A/C button is pressed, the corresponding indicator will illuminate, and the A/C will cool the air in the vehicle and have a certain dehumidification function.

The A/C indicator is always on in AUTO state (in automatic control mode, which does not indicate that it is operating). If the A/C button is pressed, A/C will exit AUTO mode and enter the mode of manual control, and the AUTO indicator will go out, but other functions will remain in AUTO mode.

## Front defroster button

Switch on the front defrost state.

When the front defrost button is pressed, the corresponding indicator will illuminate, A/C will be turned on at the same time, the mode will be adjusted to defrost; when this function is turned on, it will have a quick defrosting and defogging effect on the windshield and side window.

## Mode button

Adjust the air blowing mode.

With A/C on, when the button is pressed, the A/C air outlet mode will switch between air distribution to face, air distribution to face and footwell, air distribution to footwell, air distribution to footwell and defrost in order.

It is recommended to adopt cold air distribution to face in summer and hot air distribution to footwell in winter, which can improve the degree of comfort in the vehicle.

## Temperature control knob

Adjust the A/C setting temperature.

The temperature selection knob can be rotated and adjusted within 17 Gear Positions. Each time it is rotated clockwise by one grid with the A/C on, the A/C temperature rises by 1°C; each time it is rotated counterclockwise by one grid, the temperature drops by 1°C, and the corresponding air volume gear message is displayed in entertainment system.

When the temperature is adjusted to LO, the set temperature is the minimum; when the temperature is adjusted to HI, the set temperature is the maximum.

If continuous switching is made momentarily between different set temperatures, there is not enough time for the automatic A/C to be adjusted to the set temperature.

## Air volume increase button

Air volume increase function.

Operate the air volume increase button to increase it by 1 gear on the original basis, after the air volume is increased to 8th gear, operate it again to maintain the A/C air volume at 8th gear.

## Heating button

Controls the heating button to turn on/off.

When the heating button is pressed, the corresponding indicator will illuminate, and the A/C will enter the air heating mode, achieving the heating function inside the vehicle.

## Internal/external circulation button

To switch between internal and external circulation through the button.

When the corresponding indicator is on, it indicates that it is in the internal circulation mode. When the button is pressed again, the corresponding indicator is off, indicating that it is in the external circulation mode.

## AUTO button

Automatic air conditioning function is turned on.

Press AUTO button to enter full AUTO state, and all functions enter into auto working state; AUTO and AC indicators come on, while circulation indicator goes out, in this case, the temperature knob can be pressed as needed to set the required temperature, and the A/C system will automatically adjust the in-vehicle environment based on the set temperature.

In AUTO state, when the mode buttons, air volume button and A/C button are pressed, the panel will exit the full AUTO state, and the AUTO indicator goes out, the corresponding functions will restore to manual control state, and other unoperated functions will remain in auto state.

## Air volume decrease/OFF button

Air volume decrease/OFF function.

Operate the air volume decrease button to decrease it by 1 gear on the original basis, after the air volume is decreased to 1st gear, operate it again to turn off the A/C.

With the A/C on, if long press the button for 2s, the A/C will enter the OFF state.

## Air conditioning operating tips

- If the vehicle has been parked in direct sunlight, open the windows before operating.
- To clear misted windows on rainy days, operate the defroster button to decrease the humidity inside the vehicle timely and effectively. This is most effective during rainy weather and high humidity.
- Insufficient cooling may occur when driving in urban stop-and-go conditions.

**Note:** *If the air conditioning will not be in use for more than one month, run the vehicle at idle speed and turn on the system for more than 10 minutes (once every month, including in winter). This aims to maintain the proper lubrication of the compressor and the seals, so as to extend the service life of the system.*

**Note:** *Condensation may be formed on the evaporator when the A/C is operating. So you may find a small pool of water under the vehicle after the vehicle is stopped.*

# Before You Drive

## Rear view mirrors

The exterior rear view mirror glasses are convex shaped to broaden the field of view: this makes objects appear smaller and further away than they really are.

### Caution

Always check all mirrors for cleanliness and positioning before driving; clean and adjust if necessary.

## Exterior rear view mirrors

### Exterior rear view mirrors - power adjustment

Turn the switch to L (left) or R (right) to select the rearview mirror to be adjusted. Move the rearview mirror switch towards front/rear/left/right to adjust the rearview mirror lens to tilt towards up/down/left/right to the position required. Turn the switch to the center.

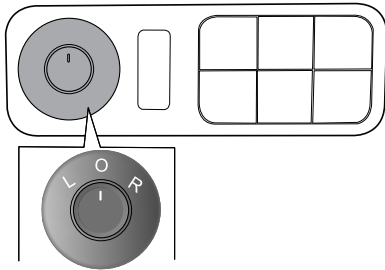

### Exterior rear view mirrors - manual adjustment

Use hands to move the mirror directly to the desired angle.

### Heated rearview mirrors

For the vehicles equipped with heated exterior rearview mirrors, press the rear Defrost button on the A/C control panel to heat the exterior rearview mirrors.

For vehicles equipped with heated rearview mirrors, press the heated rearview mirrors switch on the driver-side instrument desk to enable the exterior rearview mirror heating function.

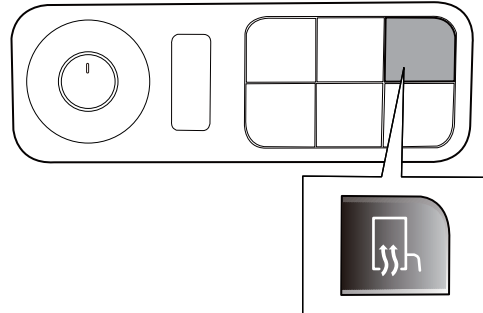



# Before You Drive

## Foldable rear view mirrors

To protect the safety of pedestrians, the exterior rear view mirrors will rotate to two sides from the normal installation position when suffering a strong impact. They can be returned by applying a small amount of force on the rear view mirror frame.

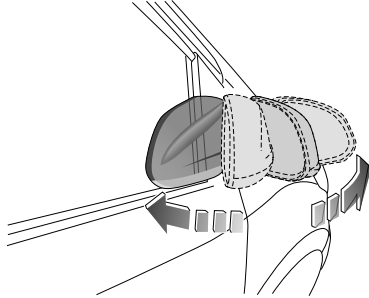

## Internal equipment



### Roof vanity light

#### Front roof vanity light

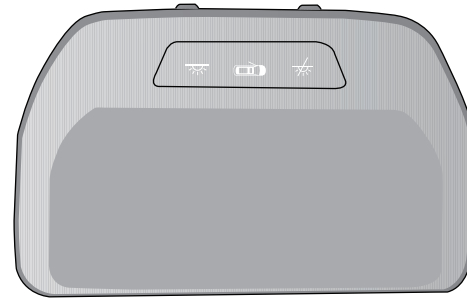
1



#### **On/Off**

Press  to turn on the front roof vanity light; press  to turn off the front roof vanity light.

#### **Turn on door control mode**

When the switch  is level, the door control mode for the front roof vanity light is turned on. In this mode, the front roof vanity light automatically illuminates if any door is opened and goes off 30s after the door is closed.

## Before You Drive

---

### Rear roof vanity light



The rear roof vanity light automatically illuminates when the tail gate or any of the side load door is opened and goes off 30s after the door is closed.

**Note:** *The roof vanity light will go out automatically after approx. 15 minutes any door is opened to avoid battery lack of power.*

### USB port

The USB port is located at the middle lower right of the instrument cluster and can be used for charging and playing multimedia files. For the method of USB playback of multimedia files as well as the requirements on the files see "Entertainment system".

The USB port on the auxiliary instrument panel supports the charging function.

#### Caution

Please avoid using the USB port for a long time when the power switch is placed in position 'ACC (UNLOCK)', which will lead to battery drain.

# Before You Drive

## USB interface at the middle lower right of the instrument cluster

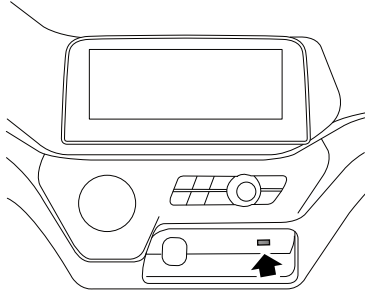

## USB port on the auxiliary instrument panel

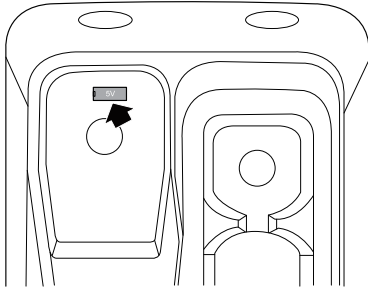

## 12V power outlet

The power outlet is located at the middle lower left of the instrument cluster and mainly used for providing power supply connection for external electric equipment.

### Caution

Please avoid using the power outlet for a long time when the power switch is placed in position 'ACC (UNLOCK)', which will lead to battery drain.

**Note:** *The power outlet can supply power to the electrical equipment with the power of less than 120W.*

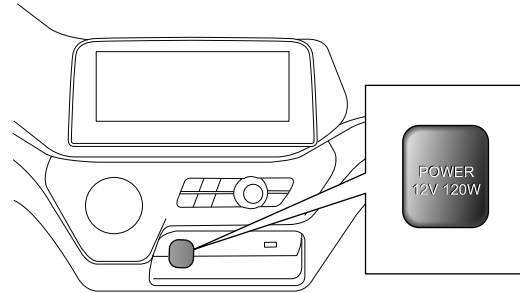

## Before You Drive

---

### Glove box

**⚠ Do not stow sharp, heavy or dangerous objects in the glove box on the occupant side.**

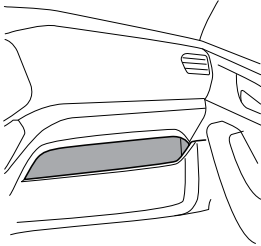

### Sun visors

Both sun visors can be swung up and down to provide a shield through the windshield. In addition they can be pivoted to shield through the side windows.

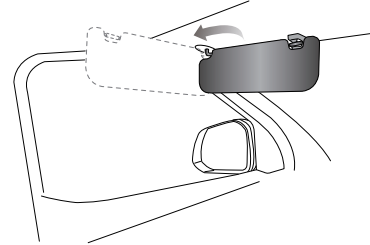

# Before You Drive

## Driver's tools

**Note:** The type of vehicle tools on your vehicle shall be subject to the actual vehicle configuration you purchased.

Driver's tool package is located under the driver's seat.

### Type 1

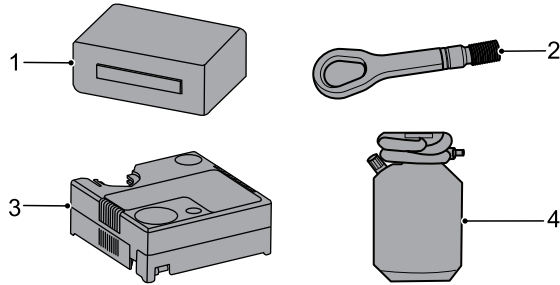

- 1 Toolkit
- 2 Towing hitch
- 3 Tire inflator
- 4 Tire sealant can

### Type 2

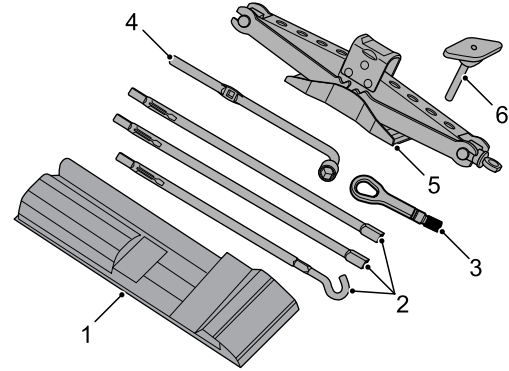

- 1 Vehicle toolkit
- 2 Auxiliary rotary extension rod
- 3 Towing hitch
- 4 Wheel nut wrench
- 5 Jack
- 6 Jack mounting screw

# Before You Drive

## Entertainment system

### Precautions before use

The contents of this Handbook are simple instructions for the operation of the product. Please read carefully and fully understand the operating instructions accompanied with the entertainment system head unit before you use this product.

 **Please do not install or repair your product without authorization. If the product is installed or repaired by a person who does not receive the training on electronic equipment and auto parts, a dangerous situation may be posed. Never expose the product to any liquid, otherwise short circuit or damage may be caused.**

**According to the relevant national regulations, watching videos and related operations are prohibited when driving, for the personal safety of yourself and others. Please do not watch the screen and perform related operations when driving a vehicle.**

**Please pay attention to all precautions mentioned in this section of the Handbook and strictly follow the operating instructions.**

**The rear view camera function of the system just serves as a driving assist. Please pay attention to the actual situation.**

### Caution

- The product shall be kept away from moisture.
- If the product is started for the first time or reconnected after the disconnection of vehicle power supply, the date shown on each interface of the head unit needs to be adjusted manually.
- Be sure to drive safely. Make sure to follow the rules of safe driving and existing traffic regulations.
- Do not operate the product (and the rear view camera function) if it may distract you from safe driving.
- If you have to operate by watching the screen, park the vehicle in a safe place and apply the parking brake.
- Do not set the volume of the product too high, or you will not be able to hear the traffic and emergency signals outside.
- For the sake of safety, some features, such as video playback, will be disabled when driving.
- The system can detect the running speed of the vehicle. When the speed exceeds a certain value, the system will prevent you from watching video while driving. If you want to watch the video, park the vehicle in a safe place and apply the parking brake.
- To prevent the battery from running out, make sure to start the vehicle when using the system.
- The pictures in this Handbook are schematic diagrams which may be slightly different from the real car in details and are for reference only. As for the specific colors and functions of the interface, please refer to the real car.

# Before You Drive

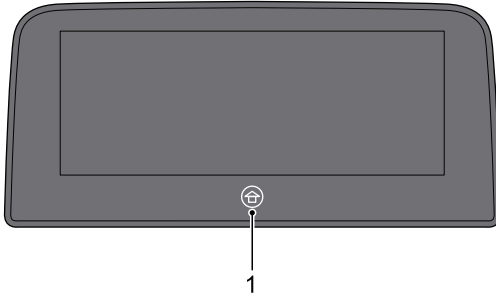

## 1 HOME button

Short press the HOME button to return to the HOME page from other interfaces; if the current page is the HOME page, this action is invalid.

Long press the HOME button for about 10 seconds to restart the entertainment system.

## Application center

- 1 On the HOME screen, click the "Application Center" icon ① to expand all application interfaces.
- 2 On the application interface, click the "User Manual" icon ② in the application center to view the instructions of the entertainment system.

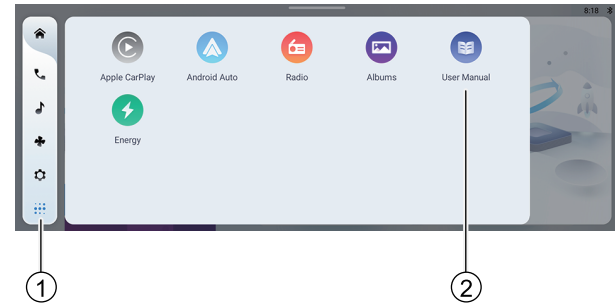

**Note:** As the entertainment system software will continue to be updated and iterated, the pictures in this manual are only schematic diagrams, which may be slightly different from this vehicle. They are for reference only, and the actual vehicle status shall prevail.





## Starting and Driving

---

- 66 Before starting and driving
  - 66 Power switch
  - 67 Starting / Stopping
  - 68 Driving
  - 69 Gear shifting
  - 71 Charging requirement
  - 84 Exterior discharge
  - 86 Acoustic vehicle alerting system (AVAS)
  - 87 Electric power steering unit
  - 88 Brake system
  - 93 Cruise control system
  - 96 Parking assist system
  - 98 Driver assistance system
  - 109 Tires
  - 110 Loading
  - 112 Trailer towing
-

# Starting and Driving

## Before starting and driving

- Ensure that the daily/weekly maintenance checks have been done as detailed in the section "Maintenance and Service - Owner's Check".
- Check your seating position.
- Check the adjustment of all the rear view mirrors.
- Check that all lights, signaling systems and warning indicators are in working order.
- Check that all occupants have correctly fastened seat belts.

Turn the power switch to position 'ON' and check the operation of all warning lights and gauges (see "Warning lights and indicators").

### Caution

Be sure you understand your vehicle and its equipment by first reading the section "Before You Drive".

## Power switch



**Never remove the key during vehicle driving, otherwise you will not be able to steer the vehicle.**

**Always remove the key after switching off, particularly if leaving children unattended in the vehicle.**

**Freewheeling with the power switched-off is dangerous as assistance from the brake servo and the power steering is not available under these conditions.**

Power switch can offer positions below:

**LOCK:** Power switch turned off. The key can only be inserted or removed in this position. After removing the key from 'LOCK' position, the power switch shall lock the steering column to avoid turning the steering wheel.

**ACC (UNLOCK):** With steering column unlocked, individual electrical equipment and accessory can work, such as radio and cigarette lighter.

**Note:** *Slight movement of the steering wheel may be necessary to disengage the steering lock.*

**Note:** *Never leave the key in 'ACC (UNLOCK)' position for a long time to avoid the battery lack of power.*

**ON:** The power is switched on and instruments, controls and electrical circuits become operative.

# Starting and Driving

START: Starter motor works. Release the key as soon as the vehicle starts and the key automatically returns to position 'ON' from position 'START'.

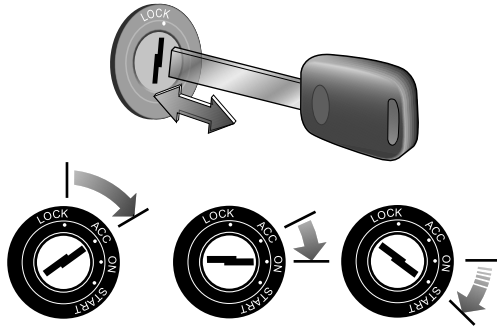

## Starting / Stopping

### Starting

The shift knob will be adjusted to 'P'.

Depress the brake pedal and maintain.

The key will be adjusted to the 'START' position, the vehicle will be started. After the motor starts to operate, the key will be immediately loosened; power switch will be automatically switched over to the 'ON' position.

2

#### Caution

The "READY indicator (green)" on the instrument cluster is used to indicate that the vehicle is ready for running. After the vehicle is started, the "READY indicator (green)" on the instrument cluster will be lit. This light will not go out in the running process.

### Stopping

Turn the power switch from 'ON' to 'OFF' position to stop the motor.

For vehicles equipped with the PEPS system, see "Power switch".

Pull up the parking brake handle.

# Starting and Driving

---

## Driving

 **When driving, never place portable container with fuel on the vehicle. They may leak and a fire may result.**

When driving on a risky road covered with water, snow, ice, mud, sand, etc., please:

- Slow down, drive with care and reserve longer brake distance.
- Avoid any sudden operation during braking, steering or acceleration.
- Apply sand or other anti-skid material under the drive wheels or install tire chains on them to provide the traction needed when the vehicle gets stuck in ice, snow or mud.

### Skid

If your vehicle skids on a wet road, you cannot control the vehicle due to the decrease of friction force between the road and tires. Different road surfaces, tire inflating pressures and vehicle speeds may lead to skid. Skid is very dangerous.

The optimum method to stop skid is lowering driving speed and keep cautious when you feel the road is wet enough.

### Wading driving

In order to avoid damage to your vehicle, when passing a road with gathered water, please:

- Confirm the water depth before the wading driving. The maximum wading depth of the vehicle is 30cm.

- Do not drive faster than 5km/h.
- The wave caused by front vehicle and head-on vehicle may exceed the maximum allowed wading depth.

 **Water and mud can affect the braking system and lengthen braking distance, leading to an accident!**

**Slightly depress the brake pedal to keep brake parts dry and recover performance.**

**Do not conduct an emergency brake when passing a slippery road.**

***Note: The motor, high-voltage battery pack, drive system and electronic system of the vehicle may be severely damaged after the vehicle drives on a road with gathered water.***

# Starting and Driving

## Gear shifting

### Shift operation

**!** Always check the condition of people near the vehicle before shifting into D or R gear, especially children. Before leaving the driver seat, always make sure the shift knob is in the P position, then pull up the handbrake and stop the electric drive.

#### Caution

To avoid damage to the electric drive reducer, do not perform acceleration operations with the brake pedal pressed into the R or D position. Use the handbrake to brake when the vehicle is parked on a slope. Do not switch the shift lever from N or P gear to D or R gear without pressing the brake pedal.

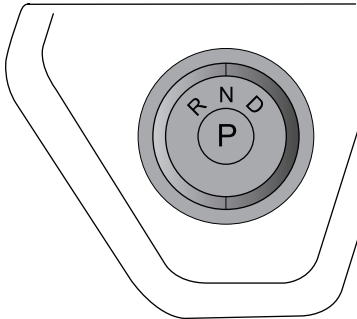

### P (Park Gear)

**!** Do not enter P gear while the vehicle is in motion. The vehicle must come to a complete stop before entering P gear or exiting P gear. Do not use P gear to brake instead of the brake pedal. Always make sure the shift lever is in P gear and fully pull up the handbrake. This position locks the electric drive reducer output shaft to prevent the drive wheels from rotating.

Exit P gear: After starting the electric drive, depress the brake pedal, rotate the shift knob by one gear into N position, and the corresponding gear is displayed on the instrument cluster.

Enter P gear: When the vehicle is stopped, press the P button in the middle of the shift knob, and the vehicle enters P gear.

### R (Reverse Gear)

**!** The vehicle must come to a complete stop before entering R gear or exiting R gear.

Use this gear to reverse.

With the vehicle stopped, depress the brake pedal and hold it, rotate the shift knob counterclockwise to enter R gear, and the corresponding gear is displayed on the instrument cluster.

The electric drive does not respond to the request to enter R gear when the vehicle is not stopped.

# Starting and Driving

---

## **N (Neutral Gear)**

Enter N gear: to enter N gear from P gear, it is required to start the electric drive and depress the brake pedal, rotate the shift knob by one gear to enter N position; rotate R gear clockwise by one gear to enter N gear; rotate D gear counterclockwise by one gear to enter N gear; the corresponding gear is displayed on the instrument cluster.

When the vehicle is in gear N, neither the vehicle nor the electric drive reducer is locked, and the vehicle will slide freely down a slight slope unless the brake pedal is depressed or the handbrake is pulled up.

## **D (Drive Gear)**

This is the drive gear position.

Depress the brake pedal in N gear, rotate the shift knob clockwise by one gear into D gear, and the corresponding gear is displayed on the instrument cluster.

## **Auto park (Automatically return to P gear)**

To ensure safety, when the vehicle key is powered off, or the driver performs the operations of releasing the brake, unfastening the seat belt and opening the driver door at the same time, the vehicle automatically enters P gear with the vehicle speed equal to or less than 4km/h; when the vehicle speed is more than 4km/h, keep the current gear without entering P gear.

When the vehicle fails (battery power failure, controller failure, etc.) and the current gear is P and cannot be switched, the front wheels of the vehicle need to be lifted for towing, otherwise the electric drive reducer will be damaged.

## Charging requirement



Slow charging is generally recommended for the vehicle; frequent use of fast charging should be avoided.

Check will be conducted to confirm whether the inlets and jacks are in good condition or not before charging.

It is recommended that the charging connector should be connected to the charging inlet in the body before operating the charging equipment.

In the process of charging operation, surrounding personnel cannot contact operators, vehicle and power supply equipment.

After charging, turn the power of the charging equipment off first, then disconnect the charging connector from the charging inlet in the vehicle body, and close the charging inlet cover as well as the charging port panel on the body.

When the charging pile breaks down, immediately notify the relevant professional, and the operator cannot handle it without authorization.

Charging can be conducted in rainy days, but rainproof measures will be adopted for charging connector and charging port in the process of removing and inserting charging connector.



Charging operation need be stopped in extreme weather such as storm.

In the charging process, key cannot be inserted for starting. It is strictly forbidden to charge when there is a person in the vehicle.

Do not conduct fast charging and slow charging simultaneously.

# Starting and Driving

---

## Requirements for charging equipment

### Requirements for battery charger

- Insulation resistance  $\geq 10M\Omega$ .
- Low voltage auxiliary power supply of battery charger is between 15A and 20A.
- As low-voltage platform of the vehicle is 12V, charging pile whose low voltage output is 12V will be used for charging to avoid damaging low voltage equipment of vehicle.
- The high voltage output of the charger is greater than 410V.

### Special requirements

- The charging equipment must meet Standard IEC 62196.

## Safety instructions for charging with residential electricity

### Basic principles

- Charging pile is not provided for charging with residential electricity. For charging piles purchased by customers themselves, it is recommended being installed by professionals.
- When charging from a household outlet, avoid using other electrical equipment on the same power line.
- Power supply circuit at the customer side shall be evaluated by qualified professionals.

### Requirements for electricity leakage protection device

- Electricity leakage protection device shall be used on the power supply circuit at the customer side, and installed at the frontmost end of the power supply circuit.
- High-sensitivity high-speed electricity leakage protection devices with a sensitive current of 30mA or smaller leakage current value are recommended.

### Requirements for over-current protector (air switch)

- Over-current protector must be installed on the power supply circuit, behind and close to the electricity leakage protection device.



# Starting and Driving

---

## Requirements for circuit cable

- Power supply circuit at the customer side must be a special circuit, and circuit wiring shall conform to the related requirements for building and electricity.
- For old buildings, it is recommended arranging new special circuit.
- The diameter of power supply circuit cable at the customer side shall be no less than 4 mm<sup>2</sup> and the total length of cable shall be no more than 50 m.
- Circuit wiring shall avoid the humid or water logged area and be free of flammable substances around.

## Requirements for household socket outlet

- Socket must be arranged in positions convenient for vehicle parking and charging operation.
- Standard 220V/13A (Users in British standard area) or 220V/16A (Users in German standard area or in Israel standard area) AC power sockets are recommended.
- The wiring of the socket should be correct (live wire, neutral wire and earth wire), and the earth wire should be reliably earthed.
- Transfers using adapters, reels, power strips, etc. are prohibited.
- The socket must be protected from rain, sun and foreign objects, and there is no heat source around.
- The socket shall conform to the requirements of IEC 60884, and be reliable in quality.

## Miscellaneous

- After the battery is fully charged, disconnect the charging cable; if it is needed to actively stop the charging, first disconnect the charging connector from the vehicle, and remove the plug at the power supply side.
- During charging operation in rainy days, rain shall be avoided from entering the charging connector and inlet.
- Check the connector/inlet for deformation, blackening or ablation before each charge, and replace it immediately if any abnormal condition is found. Even if there is no abnormal condition, if it is used for over 3 years, replace it with a new one.
- If there is peculiar smell, smoking, overheating or other abnormal conditions during charging, immediately turn off the charging circuit, stop the charging operation and check the connector and inlet.
- If the over-temperature fault lamp for charging cable illuminates, check the connector/inlet for deformation, blackening or ablation, and replace it immediately if any abnormal condition is found.

# Starting and Driving

---

## Requirements for charging environment

- Spark may be generated in some modules of charging equipment. To avoid accident, do not conduct charging operation in gas station and places where there are inflammable gases or liquid.
- Charging operation time will be affected by external temperature. Charging time will be extended at low temperatures.

## Influence of charging operation on special personnel

When conducting fast charging, the operation area may have magnetic field interference. It is recommended that users who carry implantable heart pacemaker and implantable angiocardy defibrillator keep away from vehicles under charging.

Magnetic field interference may affect normal effect of electronic medical equipment such as implantable heart pacemaker and implantable angiocardy defibrillator. Users who carry implantable heart pacemaker and implantable angiocardy defibrillator may be injured or die.

If you carry implantable heart pacemaker and implantable angiocardy defibrillator, please guarantee when vehicle is under charging operation:

- Don't stay in the vehicle.
- Don't enter into the vehicle for taking objects in the passenger compartment.
- Don't open the tail gate or enter into the vehicle for taking objects at the tail gate.

**Note:** *When the vehicle does not conduct charging operation, special personnel can ride and drive vehicles.*

# Starting and Driving

## Charging mode

### Charging pile DC charging (fast charging)

Use the public DC charging piles to charge your vehicle.

Please refer to the following table and attached drawings. The **K** label on the vehicle charging port indicates that the vehicle supports the fast charging shown in the following table.

### Household single-phase AC charging (slow charging)

Connect the vehicle to a household standard household socket to charge the vehicle, if the socket is not well grounded, the charging device will have a failure prompt for unable to charge. You need to contact a professional electrician to repair the ground wire or connect it to a well-grounded socket for charging. Check the power socket in the process of charging. If it is hot, do not continue to use it. Contact a qualified electrician for servicing the power socket.

Always use the standard household socket which meets the provisions in IEC 60884 for charging.

If a 'Electric Leakage' prompt is displayed, contact a professional electrician to check the insulation status of the hot wire or the neutral wire.

Special power sockets should be selected for battery charging, as they can prevent line damage and protection trip caused by high-power charging from affecting the normal use of other equipment. Over time, the power socket may wear out due to

normal use and may even be damaged, making it no longer suitable for charging an electric vehicle.

When used outdoors, plug it into a power socket that is protected from rain.

### Charging pile AC charging (slow charging)

Use the public AC charging piles to charge your vehicle.

Please refer to the following table and attached drawings. The **C** label on the vehicle charging port indicates that the vehicle supports the slow charging shown in the following table.

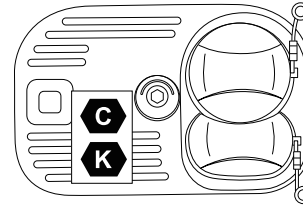

Configuration	Type of accessory	Voltage range	Identifier
TYPE 2	Vehicle inlet	≤480V RMS	<b>C</b>
FF	Vehicle inlet	50V ~ 500V	<b>K</b>

# Starting and Driving

## Fast charging

**Note:** *Fast charging should be conducted by the personnel in the fast charging station according to the operation instructions for charging pile.*

To perform a fast charging for the vehicle, turn the power switch off, remove the key, wait for 3 ~ 5 minutes, and then follow the instructions below:

- 1 Select a standard DC charging connector that matches your vehicle.
- 2 Slightly press the charging port panel at the middle emblem position by hand to open the panel.

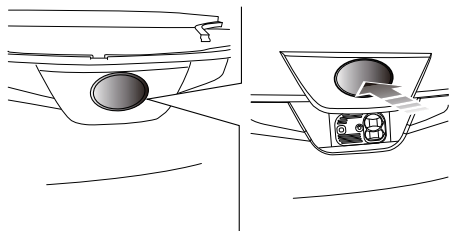

- 3 Open the cover on the charging inlet.

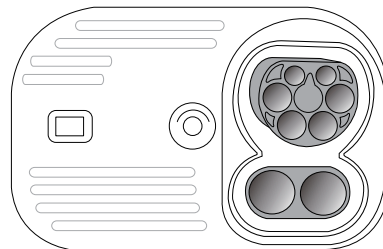

- 4 Remove the DC charging connector from the charging pile.
- 5 Connect the charging connector to the charging equipment, and turn the power of the charging equipment on according to the instructions on the charging pile.

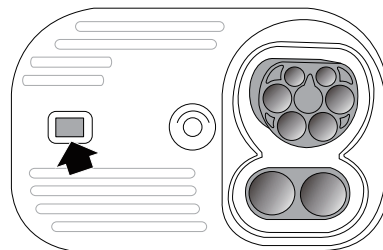

See the table below for the status of the indicator at the left side of the charging socket:

## Starting and Driving

Charging status	Color of the indicator on the charging socket	Status of the indicator
Normal charging	Green	Flash
Charging completed	Green	Always on
Charging failure	Red	Flash

**Note:** Before charging, check whether there is any abnormality in the charging equipment. In the charging process, the "charging status indicator (yellow)" on the instrument cluster flashes, and the indicator (green) at left side of the charging socket flashes. If there are no flashes after 3 consecutive attempts, it is recommended to replace other equipment for attempts. If the equipment can be charged after replacement, the previous charging equipment may be damaged.

**Note:** Please check whether the PP and CP pins of the charging connector are rusted. If so, please clean them before charging to prevent charging failure.

- 6 After the charging connector is properly connected, the "charging connection indicator (red)" on the instrument cluster will come on.

**Note:** Please make sure that the charging connector is fully inserted into the charging stand to avoid that the electronic lock cannot be locked, resulting in charging failure, as shown below.

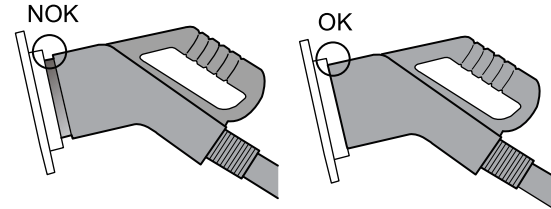

- 7 In the charging process, the "charging status indicator (yellow)" on the instrument cluster flashes, and the indicator (green) at the left side of the charging socket flashes.
- 8 Upon completion of charging, the "charging status indicator (yellow)" goes out, and the indicator (green) at the left side of the charging socket is always on. Please turn the power of the charging equipment off before removing the charging connector.

# Starting and Driving

9 Close the cover on the charging inlet.

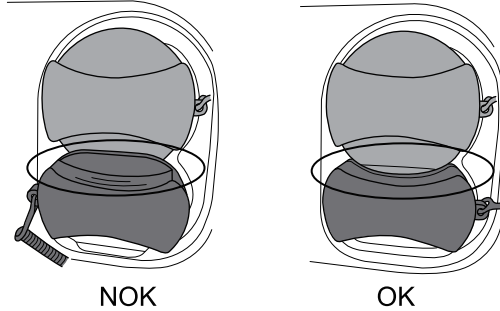

10 Close the charging port panel.

## Caution

Select a standard DC charging pile or charging equipment that matches your vehicle. Once the battery is fully charged, the battery management system will have an automatic calibration function. If the vehicle has been shallowly charged (less than 99%) every two or three times, you need to fully charge (100%) the vehicle once.

## Slow charging

There are three ways to slow charge. The charging method on your vehicle depends on the actual configuration of your vehicle.

1 Mode 2 charging is shown in the figure below. One end of the charging in this mode is connected to the household socket and the other end is connected to the vehicle. (This connector is optional for users)

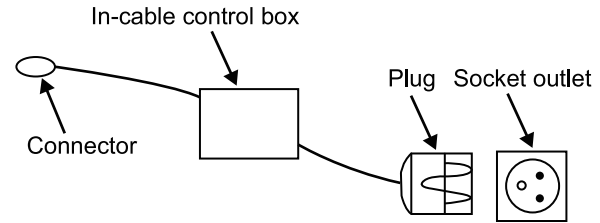

The LED words on the In-cable control box are as follows:

Charging status	Status description			
	Power (Green)	Charging (Red)	Fault (Red)	Complete (Green)
Initial state	On	Flash	Flash	Flash
To be connected	On	On	Off	Off
Normal charging	On	Off	Off	On
Charging completed	On	Off	Off	On

# Starting and Driving

Power-on self-test failed	On	Off	Flash	Off
Abnormal communication	On	On	Flash	Off
Over/under voltage	On	Off	On	Off
Ungrounded	On	Off	On	Flash
Over current	On	Flash	On	Off
Current leakage	On	Off	Flash	Flash
Over temperature	On	On	On	On

2 Mode 3 charging is shown in the figure below. One end of the charging in this mode is connected to the charging piles and the other end is connected to the vehicle. (This connector is optional for users)

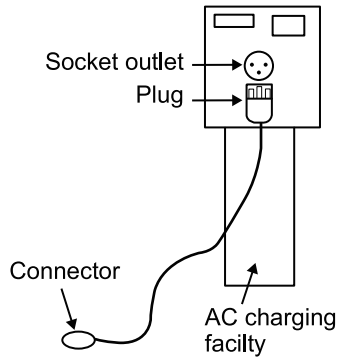

3 Direct charging with charging post.

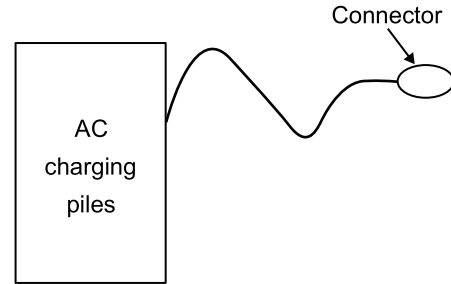

2

**Note: Slow charging is a way of charging high-voltage battery pack to reach the optimal equilibrium state.**

To perform a slow charging for the vehicle, turn the power switch off, remove the key, wait for 3 ~ 5 minutes, and then follow the instructions below:

- 1 Select the standard 13A socket (British standard socket) or 16A socket (German standard socket or Israel standard socket) with reliable earthing or AC charging piles.
  - British standard socket.

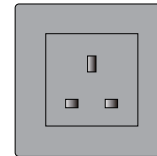

# Starting and Driving

- German standard socket.

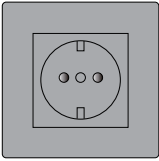

- Israel standard socket.

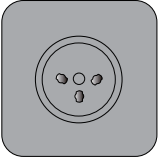

- 2 Take the charging connector out from its package.
- 3 Insert the AC input cable plug of the charging connector into the socket or AC charging piles.
- 4 Slightly press the charging port panel at the middle emblem position by hand to open the panel.

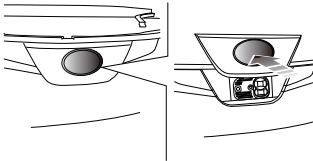

- 5 Open the cover on the charging inlet.

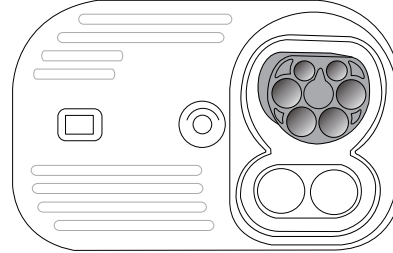

- 6 Connect the charging connector to the charging inlet.
- 7 After the charging connector is properly connected, the "charging connection indicator (red)" on the instrument cluster comes on and the electronic lock of the charging inlet is enabled, which guarantees that the charging connector will not be unplugged whilst charging.

**Note: Please make sure that the charging connector is fully inserted into the charging stand to avoid that the electronic lock cannot be locked, resulting in charging failure.**

- 8 After the above operations are completed, the system will be charged automatically within about 20 seconds.
- 9 Once the battery is fully charged, the "charging status indicator (yellow)" on the instrument cluster will go out, and the electronic lock of the charging jack will not be unlocked due to the anti-theft function. If you want to pull out the



## Starting and Driving

charging connector when charging is finished, you can unlock the electronic lock through the key.

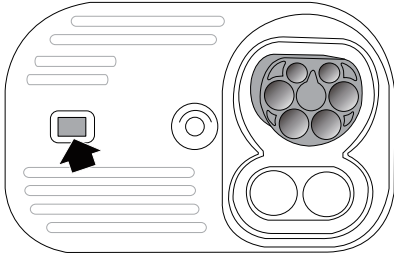

See the table below for the status of the indicator at the left side of the charging socket:

Charging status	Color of the indicator on the charging socket	Status of the indicator
Normal charging	Green	Flash
Charging completed	Green	Always on
Charging failure	Red	Flash

**Note:** To end the charging early and remove the charging connector, you could use the smart key or the ordinary key to unlock the vehicle, then the charging stops automatically, the "charging status indicator (yellow)" goes out and the electronic lock automatically unlocks. Finally, set the power switch back to the lock position.

**Note:** After charging is finished, the key will be locked again if the connector is not pulled out. If the key is switch on the position run, you need to be unlocked through the central control.

**Note:** If charging with a public AC charging pile, connect the charging connector to the charging equipment, and charge according to the instructions on the AC charging pile.

**Note:** If charging with a public AC charging pile, before charging, check whether there is any abnormality in the charging equipment. In the charging process, the "charging status indicator (yellow)" on the instrument cluster flashes, and the indicator (green) at the left side of the charging socket flashes. If there are no flashes after 3 consecutive attempts, it is recommended to replace other equipment for attempts. If the equipment can be charged after replacement, the previous charging equipment may be damaged.

**Note:** If charging with a public AC charging pile, please check whether the PP and CP pins of the charging connector are rusted. If so, please clean them before charging to prevent charging failure.

- 10 Close the cover on the charging inlet.
- 11 Close the charging port panel.
- 12 Stow the charging connector in its package.

# Starting and Driving

## Caution

Emergency treatment: In the event of an emergency such as fire, smoke or burnt smell, turn the socket power switch off immediately to completely power off the system. If the vehicle has been shallowly charged (less than 99%) every two or three times, you need to fully charge (100%) the vehicle once.

## Caution

- If any unidentified foreign matters are found in the charging plug, insulator, pin and socket, the charging process shall be terminated immediately.
- It is strictly prohibited to insert the charging plug and charging base obliquely.
- It is strictly prohibited to shake the charging plug up, down, left and right when inserting / pulling it out, and it must be inserted / pulled out with vertical force.
- During charging, the cable of charging plug must be smoothed, and it is not allowed to distort to force the charging connector seat during use.
- During the charging process, in case of extremely severe weather such as typhoon, rainstorm and hail, the charging process shall be terminated immediately.
- During the charging process, if the charging interface continuously emits strong and irritating odor, the charging process shall be terminated immediately.

## Charging inlet emergency cable

The AC charging inlet has an electronic lock function, which prevents children from touching or accidental unplugging of the charging connector in the process of charging. After the charging connector is inserted into the AC charging inlet, the electronic lock in the charging inlet locks along with the main control switch of the vehicle. Do not force the charging connector out, or it may cause damage to the vehicle. The charging connector can only be pulled out after the vehicle is unlocked using the key or the main control switch. If the key or the main control switch cannot be used to unlock the charging connector, you may pull out the emergency cable below the hood lock to unlock the charging connector.

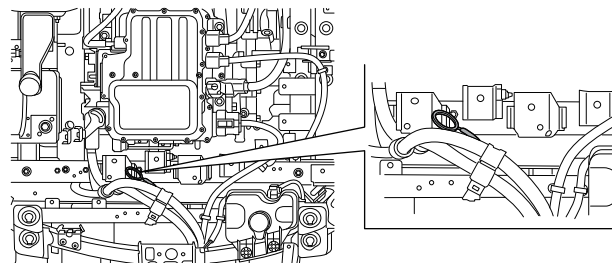

# Starting and Driving

## Charging information

Rated charging voltage	Charging power	Charging stand standard	Slow charging standard	Fast charging standard	Anti theft of slow charging connector
361.3V	Max. 65kW	CCS2	IEC61851	DIN70121	Anti theft

## Equalizing charge

Equalizing charging means that during the charging process, under the action of the battery management system, the voltage of each cell is basically the same, so as to ensure the overall performance of the high-voltage battery pack. Therefore, it is recommended to charge the vehicle at least once a month with a slow full charge of less than 25% of its battery capacity to improve battery performance and lifespan.

**Note: For charging safety reasons, the upper limit of DC fast charging capacity is 97%, and the upper limit of AC slow charging capacity is 100%.**

## Charging time

Charging time of high-voltage battery pack is related to many factors, such as current electric quantity, charging mode, ambient temperature and charging device power.

## Fast charging time

At room temperature, if the charging equipment has an output capacity of over 105 kW, it will take approx. 45 minutes to charge the battery to 80% (80% battery level displayed on the instrument cluster) from the alarm status (illuminated low battery warning lamp of high-voltage battery pack on the instrument cluster).

### Caution

- At a low temperature and in an extremely high temperature environment, the required charging time will be extended.
- If the output capacity of charging device is insufficient, the required charging time will be extended.

**Note: In order to protect the high voltage-battery pack and to speed up the temperature rise of the battery, when performing a fast charge in a low temperature environment, the high voltage-battery pack may have a drop in capacity for a short period of time, it is normal.**

# Starting and Driving

---

## Slow charging time

At room temperature, it takes almost 6 to 8 hours to charge the battery from the alarm status (illuminated low battery warning lamp of high-voltage battery pack on the instrument cluster) to 100%.

### Caution

- At a low temperature, the required charging time will be extended. If the air conditioner and other high-power electrical appliances are turned on during slow charging at low temperature, it may result in power level drop and the charging time will be extended accordingly, so the use of air conditioners and other high-power electrical appliances shall be minimized during slow charging.
- If it is not fully charged for a long time, it may lead to inaccurate estimation of driving range, and the charging time required for recharging may be extended.
- After long-term parking, the vehicle needs to be fully charged before its first use, and the charging time may be extended.

***Note: The slow charging time mentioned above means the time required by the vehicle to use AC charging pile for charging. When the residential electricity is used for charging, corresponding charging time will be about 2.5 times of that required for adopting AC charging pile.***

## Exterior discharge

***Note: It applies to vehicles configured the exterior discharge function.***

## Discharge requirements

- Only the slow charging port can be used for discharge.
- Check whether the socket and jack are in good condition before discharge. Do not discharge with a discharger that is damaged, rusted, damp or has foreign objects. Do not discharge with a discharge port that is stained by water. Do not discharge with discharger head and discharge socket that are deformed, blackened or ablated.
- It is recommended that the discharge handle should be connected to the discharge socket (i.e. AC charge socket) in the body before operating the central control screen.
- In the process of discharge operation, surrounding personnel cannot contact operators, vehicle and discharger.
- The vehicle will perform discharge power protection depending on the discharger specifications. Be careful not to use a high-power electrical appliance that exceeds the discharger specifications or use multiple electrical appliances with high power at the same time. During use, please observe the discharge current displayed on the meter. When the discharge function is stopped due to protection, unplug the electrical appliance and try again.
- After discharge, turn off the electric appliance first, then disconnect the discharger from the vehicle's charge socket,

# Starting and Driving

and close the plastic cover of the charge socket and the charging port door on the body.

- When the charge socket fails, immediately notify the relevant professional, and the operator cannot handle it without authorisation.
- Discharge can be conducted in rainy days, but rainproof measures shall be taken for discharger and discharge port and socket in the process of removing and inserting discharger.
- Discharge operation needs be stopped in extreme weather such as storm.

## Requirements for discharge environment

The discharger and electrical appliances may cause sparks during discharge. In order to avoid accidents, do not discharge at gas stations or places with inflammable gases or liquids.

## Discharge operation

Follow the instructions below during discharge:

- 1 The discharge port is at the front of the vehicle. Slightly press the charging port panel at the middle emblem position by hand to open the panel.

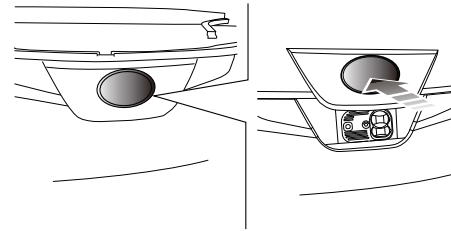

- 2 Open the cover of the discharge socket, i.e. the cover on the AC charge socket of the vehicle.

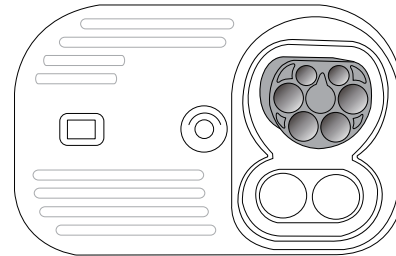

- 3 Connect the discharger to the discharge socket.
- 4 After the discharger is connected, enter Exterior Discharge on the central control screen, set the battery discharge cutoff power, and tap the Start Discharge icon.

## Starting and Driving

**Note:** Since the software of entertainment system will be updated constantly, please refer to the actual vehicle status.

- 5 After the above operations, the system will start discharge within 20s.
- 6 To end the discharge, tap the Stop Discharge icon under Exterior Discharge on the central control screen.
- 7 Unlock the vehicle, remove the discharger, cover the cover of the discharge socket, and close the charging port panel.

### Caution

Emergency response: If an emergency such as fire, smoke or burnt odor is found during use, turn off the discharge socket switch immediately to fully cut off the system.

## Acoustic vehicle alerting system (AVAS)

**Note:** It is applicable to the vehicle equipped with the AVAS.

Battery electric vehicles are quieter when driven at low speeds, resulting in a higher probability of traffic accidents with pedestrians (especially blind people) than with conventional cars. The acoustic vehicle alerting system (AVAS) can emit warning tones or beeps at low speeds, helping reduce the probability of traffic accidents with pedestrians.

The balance between ensuring safety and reducing noise pollution is achieved through audible warning and sound effect design for different groups of people with different sound sensitivity.

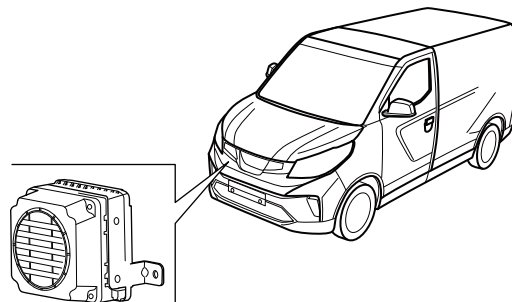

### **Acoustic vehicle alerting system (AVAS) sound effect**

When the vehicle travels at a speed of 0 to 20 km/h, the AVAS will simulate the sound of engine running and give out an audible warning. The warning tone gradually increases as the vehicle speeds up and decreases as the vehicle slows down, thereby reminding people outside that the vehicle is passing by. The minimum average frequency shift speed of this frequency meets  $\geq 0.8\%$  / (km/h).

**Note: When the vehicle travels at 0 km/h, the AVAS will not give a warning sound.**

When reversing, the AVAS will emit an audible warning that simulates the sound of engine running to remind people outside that the vehicle is reversing. The warning tone increases as the vehicle speeds up and decreases as the vehicle slows down.

**Note: When the vehicle is reversed at 0 km/h, the AVAS will not give a warning sound.**

**Note: The low-speed alarm function can be turned off by pressing the AVAS switch on the driver-side instrument desk. Pressing the AVAS switch illuminates the indicator on it and turns off the low-speed pedestrian alert function.**

### **Electric power steering unit**

The electric power steering system allows you to steer with less force.

When the steering system fails or the motor turns off (the vehicle is towed by another vehicle), the driver can still maintain full control over the steering while needs to apply greater force to operate the steering wheel.

# Starting and Driving

---

## Brake system

### Service brake

#### Dual brake hydraulic system

 A failure in one of the hydraulic pipelines will be indicated by illumination of the "braking system

warning light (red)"  on the instrument cluster while driving; it will result in increased brake pedal travel and effort, longer stopping distance and may cause the vehicle to pull to one side. Do not pump the brake pedal in an attempt to restore pedal pressure. If there is pressure failure in one of the brake pipelines the cause must be investigated. **IMMEDIATELY bring the vehicle carefully to a halt. You should contact our Service Dealer immediately. Do NOT drive the vehicle.**

Should one of the hydraulic pipelines fail the other circuit will continue to function.

#### General state

 Always ensure that floor mats or other objects do not disturb pedal movement.

Never rest your foot on the brake pedal as this may overheat the brakes, reduce their efficiency and cause excessive wear. If brake pads/shoes have worn excessively, a squealing or screeching noise will be heard when the brakes are applied, and braking efficiency will be affected. Contact our Service Dealer for service as soon as possible.

If the drive motor stalls or stops for whatever reason, the brake servo assistance will exhaust after two pedal operations and as a result a much greater effort will be required in operating the pedal to achieve expected braking efficiency. In these circumstances the stopping distance may be longer.

If the vehicle is not in regular use or is garaged for long periods the efficiency of the braking system could be impaired. Contact our Service Dealer for service as soon as possible.



## Wet state

 **Driving in heavy rain and slushy roads will considerably reduce braking efficiency. At this time, keep safe distance from other vehicles and gently depress the brake pedal intermittently to dry the brake friction components. In severe wet weather this drying process may need to be repeated every few miles.**

**In winter month ice can form and salt accumulate on the brake pads and discs. Ice and salt accumulation will be cleaned off after a few light applications of the brake pedal.**

## Descending steep hills

 **Overheating the brakes will reduce braking efficiency and may also cause the vehicle to pull to one side.**

## ABS (Anti-lock braking system)

Your ABS prevents the road wheels from locking under severe braking; thereby helping you to maintain steering control. No special driving technique is needed.

Under normal braking (where sufficient road surface friction exists to prevent wheel lock), the ABS will not be activated.

An integral feature of this braking system is Electronic Brake Distribution (EBD), which is used to optimize the braking force at the rear wheels under full load condition.

## ABS in action

 **ABS does not necessarily provide shorter stopping distances, which can vary greatly depending on road surface and conditions. In fact, stopping distances can be less on vehicles without ABS on some surfaces such as gravel and soft snow.**

**ABS cannot overcome the physical limitations of stopping your vehicle in too short a distance, cornering at high speed, or aquaplaning, i.e. where a layer of water prevents adequate contact between the tires and the road surface.**

**ABS must never tempt you to take risks that could affect your safety or that of other road users. You still have a duty to drive within normal safety margins, having due consideration for the road surface, weather and traffic conditions.**

# Starting and Driving

---

If the force of your braking should exceed the available adhesion between the tires and the road, causing one or more wheels to lock, then ABS will automatically come into operation. You will hear the sound of a rapid pulsation which will also be felt through the brake pedal.

When braking in an emergency, always depress full force to the brake pedal, even if the road surface is slippery. ABS is activated immediately; it constantly monitors the speed of each wheel and varies the braking pressure to each according to the amount of grip available.

This prevents the wheels from locking and enables steering control to be maintained.

## **Driving tips With ABS**

- In an emergency braking situation, depress full force to the brake pedal.
- Under normal braking, apply steady pressure to the brake pedal - DO NOT PUMP IT.
- Remember that steering control will always be available during braking.
- The availability of ABS does not eliminate the dangers of driving too close to the vehicle in front, aquaplaning, excessive cornering speeds, etc.
- ABS does NOT guarantee shorter braking distances.
- Do not be alarmed if you hear and feel a pulsing at the brake pedal. This is normal and indicates that the ABS is in operation.

## **ESP (Electronic Stability Program)**

### **ESP function**

ESP covers the functions of ABS, EBD, TCS, VDC, EBA, RMI and HAS.

ESP Indicator on the instrument cluster flashes when the ESP is operating. You may hear some noise or feel the vibration of brake pedal, which is normal.

When the ignition switch is placed in "ON" position, "ESP indicator (yellow)" will illuminate and go off after several seconds. In normal driving conditions, ESP indicator keeps off, and ESP is in monitoring state. When the ESP indicator blinks, it indicates ESP is operating. You may hear some noise or feel the vibration of brake pedal, which is a normal phenomenon. In case of ESP failure, ESP indicator will stay On. Please take the vehicle to Our Service Dealer for ESP inspection.

ESP can be turned off with ESP OFF switch, and when ESP function is turned off, only ABS and EBD functions are available.

### ***EBD (Electronic Brake-force Distribution)***

EBD automatically detects the grip conditions between wheels and ground, distributes the brake force optimally to 4 wheels, so as to improve brake efficiency and driving stability.

# Starting and Driving

---

## ***TCS (Traction Control System)***

TCS automatically controls the driving force at the start-off and acceleration to prevent wheels from spinning, so as to maintain the driving stability.

## ***VDC (Vehicle Dynamics Control)***

VDC is an advanced computer system, which can help you to control the vehicle driving direction in severe driving conditions. When the computer detects the deviation between the expected driving route and the actual driving direction, VDC system may selectively apply brake pressure on one or more brakes of the vehicle so as to keep the vehicle driving in the direction commanded.

## ***EBA (Electronic Brake Assist)***

In case of an emergency, the force applied by a driver on the brake pedal is usually insufficient. EBA can identify this rapid action with insufficient force on the brake pedal and automatically establishes a brake pressure up to the lock level to shorten the brake distance greatly.

## ***RMI (Roll Movement Intervention)***

RMI can identify the vehicle rollover trend as early as possible by monitoring the turning angle of steering wheel and lateral acceleration, and apply braking to one or more wheels to prevent the rollover to the greatest extent.

## ***HAS (Hill-start Assist System)***

When the vehicle drives uphill, HAS can prevent the vehicle from sliding backwards after the driver releases the brake pedal. The driver has up to 1.5s to move his foot from the brake pedal to the accelerator pedal for hill-start.

## **Precautions for driving a vehicle with ESP**

ESP can detect and analyze vehicle conditions, and take preventive measures by correcting wrong driving operation. However, anything has its limit and no safety device is absolutely safe if the driver blindly drives the vehicle over-speeding.

# Starting and Driving

## Parking brake

### Pull up the parking brake handle.

- Press the brake pedal hard to the end.
- Pull up the parking brake handle with effort, and ensure it is locked in the 'Upper' position.
- Release the brake pedal and ensure the vehicle is already in stationary state.
- If the vehicle still moves, pull up the parking brake handle with greater effort.

**Note:** *When parking, set the vehicle to P gear.*

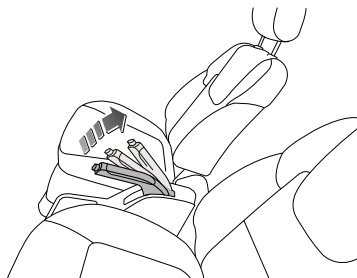

With the power switch in position 'ON', pulling up the parking brake handle will illuminate the "parking brake warning light (red)" on the instrument cluster.

## Ramp parking

When parking uphill, turn the front wheels away from the curb. When parking downhill, turn the front wheels to the curb.

## Release the parking brake handle

**!** Before the power switch is turned on, do not release the parking brake handle. Otherwise vehicle may slip backwards, and the vehicle can not make a hill start. Before driving, ensure the parking brake handle has been fully released, and the "parking brake warning light (red)" on the instrument cluster has gone out, because partial braking may lead to overheat, efficiency reduction and excessive wear of rear brakes and even an accident.

Slightly pull up the parking brake handle, then press the button at the end of lever, and push the handle fully down.

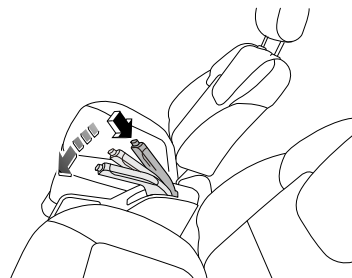

### Warning lights

Warning lights related to brake system are "brake system warning light (red)", "parking brake warning light (red)", "ABS warning light (yellow)", "EBD warning light (red)", "ESP indicator (yellow)" and "ESP OFF indicator (yellow)". See "Warning lights and indicators".

### Cruise control system



**Cruise control can be dangerous where you can not drive safely at a steady speed. Therefore, do not use the cruise control on winding roads or in heavy traffic. It is also dangerous to use the cruise control system while driving on a slippery road. On such roads, fast changes in tire traction can cause excessive wheel spin, and you could lose control. Do not use the cruise control on a slippery road.**

Your vehicle may be equipped with the cruise control system. With the cruise control, you can maintain the vehicle speed at 40km/h or above without keeping depressing the accelerator pedal. The cruise control system does not work when the vehicle speed is less than 40 km/h.

For vehicles with the traction control system or electronic stability control system, the system starts to limit wheel spinning when the cruise control system is working. In case of this situation, the cruise control will be automatically disabled.

# Starting and Driving

## Cruise control settings

### Setting cruise control



**!** If the cruise control stays on when you do not use it, you may touch the button and accidentally enter the cruise state. Then you may get scared and lose control of the vehicle. Therefore, keep the cruise control switch "Off" until you need to use the cruise function.

The cruise control switch is located on the steering wheel.

 : Cruise On/Off switch. Press this button to turn on/off the cruise control system. The "cruise control indicator" in the instrument cluster illuminates or goes out accordingly.

 : Cruise cancel switch. Press this button to cancel the cruise function without clearing the set speed in the memory.

RES+ : Cruise recovery/acceleration switch. If a set speed has been stored, press  upwards to resume that speed; press upwards again to accelerate (1km/h per time). The instrument cluster will display the target speed.

SET- : Cruise setting/deceleration switch. Press  downwards to set a speed. Then the cruise function will be enabled and the "cruise control indicator lamp" on the instrument cluster will turn green from white. If the cruise function is operating, press  downwards to decelerate (1km/h per time). The instrument cluster will display the target speed.



### Setting speed

- 1 Press  to turn on the cruise control system. Meanwhile the "cruise indicator lamp (white)" in the instrument cluster will illuminate.
- 2 Accelerate to the desired speed.

**Note: This speed must be higher than 40km/h.**



- 3 Press  downwards towards SET- and then release it. Then the current speed will be stored and maintained. The speed set will appear in the instrument cluster display momentarily, and the "cruise indicator lamp" on the instrument cluster will turn green from white.
- 4 Release the accelerator pedal, and then the vehicle will cruise at a steady speed. The cruise control function will be disabled when the brake is enabled.

### Resume the set speed

If you have set the cruise speed of cruise control system, the cruise control function will be disabled when you depress the brake pedal or press , but this set speed in the memory will not be cleared. To resume the pre-set speed, press  upwards towards RES+ when the vehicle speed reaches 40km/h or above, and then the vehicle speed will recover to the pre-set value.



## Accelerating with cruise control enabled

There are two methods to accelerate:

- Accelerate by depressing the accelerator pedal.
- If the cruise control system has been enabled, press  upwards towards RES+, and hold it until the vehicle accelerates to the desired speed, and then release it. To accelerate by minor increment, short press  upwards towards RES+, and then release it. Each time this is done, the vehicle goes about 1.0 km/h faster, meanwhile the instrument cluster will display the incremental target speed.

## Decelerating with cruise control enabled

If the cruise control system has been enabled:

- Press  downwards towards SET-, and hold it until the vehicle decelerates to the desired speed, and then release it.
- To decelerate by minor increment, short press  downwards towards SET-, and then release it. Each time this is done, the vehicle goes about 1.0 km/h slower, meanwhile the instrument cluster will display the decremental target speed.

## Overtaking with cruise control enabled



Speed up with the accelerator pedal. When you release the accelerator pedal, the vehicle will decelerate to the pre-set cruise control speed.

## Using cruise control on slopes

The performance of cruise control system on a slope depends on the speed, load as well as the gradient of the slope. When the vehicle runs uphill, it may be required to depress the accelerator pedal to maintain the vehicle speed. When the vehicle runs downhill, it may be required to brake or shift to a low gear to maintain the vehicle speed. The cruise control function will be disabled when the brake is enabled.

## Terminating cruise control

There are three ways to disable the cruise control:

- Slightly depress the brake pedal once; the "cruise control indicator lamp" in the instrument cluster will turn white from green when the cruise control is disabled.
- Press .
- Press  to turn off the cruise control system completely. The cruise control speed will not be resumed.

## Clearing speed memory

The cruise control set speed memory will be cleared when you press  or turn off the power switch.

# Starting and Driving

## Parking assist system

**Note:** *The type of the parking assist system equipped on your vehicle depends on the actual configuration of the vehicle you purchased.*

## Parking sensor

**!** The parking assist system is not always reliable and is only playing the role of guidance! The parking sensors might not detect some types of obstacles, including slim objects (such as wire nets and ropes), small objects close to the ground, conic objects and some objects with non-reflective surfaces.

The parking sensors shall be free of dirt, ice, and snow. The sediment on surfaces of parking sensors will impair the normal functioning of the sensors. Therefore, avoid directly flushing the parking sensors from a short distance by high pressure water gun while washing your vehicle.

Two parking sensors installed on the rear bumper are functioned to scan the rearward area of vehicle, in order to judge the presence of obstacles. Upon detection of any obstacle, the parking sensors will calculate its spacing from the rear of the vehicle and send the information to the driver by alerting tones. It's really important that this system is only a parking assist system and can't function as the replacement for your observation and personal judgment.

Working status of parking sensor assist system:

After selecting reverse gear, the parking assist system will give out a 0.5s 'beep' sound to indicate operation started automatically. When selecting other gears, the parking assist system will stop working.

**Note:** *If the system gives out a 3s prompt tone, followed by a short beep or two short beep after the reverse gear is selected, it indicates the system has a malfunction. Contact our Service Dealer for service as soon as possible.*

When reversing the vehicle:

When the vehicle is at about 150 cm distance from the rear barrier, the device starts to produce alarm sound, and the alarm sound become harsh when the vehicle is approaching the barrier.

When the distance of the vehicle from the rear barrier is less than 40 cm, the device will produce continuous alarm sound. At this moment, it is impossible to effectively identify the barrier if you continue to reverse the vehicle.

Actual distance (in cm)	<40	40 ~ 70	70 ~ 100	100 ~ 150	>150
Beep frequency (in Hz)	Keep ringing	4	2	1	Beep stop



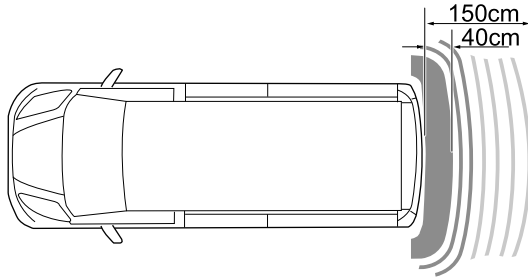

### Parking camera

**!** The parking camera assist system is not always reliable and is only playing the role of guidance! Due to limited visual field, the parking camera can't detect any obstacle beyond its visual field.

Working status of parking camera assist system:

After selecting reverse gear, the entertainment system display will be switched to the operation condition of parking camera, displaying the scene behind the vehicle as reverse reference.

When selecting other gears, the camera stops working and the display returns to the original state.

**Note:** *When the vehicle is in reverse condition, the camera outputs static reverse track with ground as the reference on the entertainment system display and identify with red, amber and green in segment.*

# Starting and Driving

## Type 1

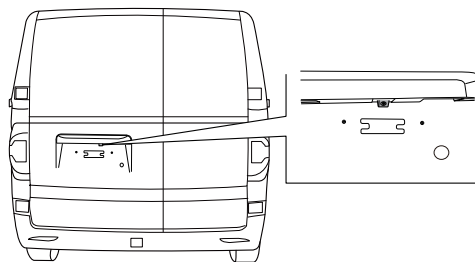

## Type 2

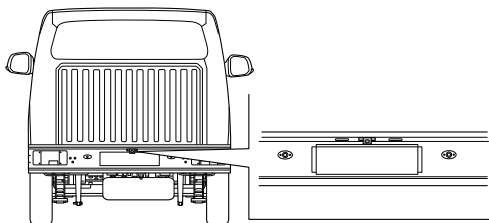

## Driver assistance system

**Note:** The type of advanced driver assistance system on your vehicle depends on the actual vehicle configuration you purchased.

## Camera

Front-view camera is installed inside the front windshield at the interior rear-view mirror. Front-view camera provides target acquisition for the driver assistance system.

### Caution

If the camera sensor hardware is damaged, it must be repaired or replaced. It is recommended to drive the vehicle to our service dealer for repair, and never replace it by yourself.

It is not allowed to install license plate frame or other objects on the front/rear license plate board to prevent interference with camera or radar sensor; regular maintenance is required for the license plate to avoid deformation from affecting the radar sensor performance.

Not all traffic environment, weather and driving conditions are suitable for the camera to function properly, therefore, in a complex environment or bad weather, please drive carefully.

## Camera maintenance

In order to keep the proper operation of camera, please ensure there is no foreign matter such as dust, ice and snow, and water on the front of camera.

When there is a foreign matter in front of the radar, please clean it with soft cloth. Never use water cannon, or damage the lens of camera.

The replaced assembly structure of camera must be our original part. After part replacement, the camera must be re-calibrated at our service dealer, so as to ensure that all vehicle systems based on the camera function properly.

## Service restrictions

When the camera cannot work properly, the function that provides detection information based on the camera is restricted or abnormal.

The camera has limited detection range and capability, so that it cannot detect the target out of its detection range.

The performance of camera will be restrained in the following environment:

- The camera's view is blocked, and the surface is covered with foreign matters, such as dust, ice and snow, water, etc.
- Weather conditions with poor light or low visibility.
- Over exposure of camera due to direct sunlight.
- Dramatic light change (e.g in/out tunnel).
- Camera jolt due to bumpy road or other factors.

## FCW and AEB (Forward collision assist)

Forward collision assist includes FCW (Forward Collision Warning) and AEB (Automatic Emergency Braking). The FCW function warns the driver of pedestrians, bicycles or vehicles in front of the vehicle with visual and audio signals. If the driver fails to take actions within a reasonable period of time, the system will trigger the AEB function.

Collision assist function may enable urgent and instantaneous braking to cope with different collision risks. These may make the driver feel uncomfortable, in this case, the driver shall perform active braking.

If the collision risks increase further, the system will brake dramatically and stop the vehicle in normal conditions. For most drivers, this is not a normal driving style and they may feel uncomfortable. After the collision assist function successfully avoids collision with the vehicle ahead, the vehicle will remain stationary for a while, at which moment the driver shall take actions as soon as possible.

Generally, the collision assist function will not be perceivable to the driver or passengers until the vehicle is about to collide. The collision assist function will be enabled when the driver should start braking in advance, but it cannot help the driver in all conditions.

# Starting and Driving

## Function on or off

### **Function on mode**

When the vehicle is started, the collision assist function is on by default.

If you turn the function off and want to turn on it again, set in the entertainment system screen: Settings->Advanced Driver Assistance->Collision Assist On.

When the function is activated, the "FCW (Forward Collision Warning)/AEB (Automatic Emergency Braking) warning light

(yellow)"  on the instrument cluster goes out.

### **Function off mode**

Set in the entertainment system screen: Settings->Advanced Driver Assistance->Collision Assist Off.



When the function is off, the FCW and AEB functions will be disabled at the same time, and "FCW warning light/AEB warning

light (yellow)"  on the instrument cluster is always on.

### **Sensitivity control**

Set in the entertainment system screen, and click "...” or ">” on the right of Collision Assist, the options "Low", "Standard" and "High" will pop up; you may select applicable sensitivity according to your needs.

## Information prompt

- Visual alarm
  - Indicator prompt: During the forward collision warning, the "FCW (Forward Collision Warning)/AEB (Automatic Emergency Braking) warning light (yellow)"  flashes; during the automatic emergency braking, the "FCW (Forward Collision Warning)/AEB (Automatic Emergency Braking) warning light (red)"  flashes.
  - Text reminder: Risk of collision/automatic emergency braking.
- Audible alarm: The entertainment system speaker alarms.

### Caution

The collision assist is an auxiliary function that cannot work under all driving, traffic, weather and road conditions, which cannot replace the driving and accurate judgment. The performance of the system may be degraded by other factors, so that the driver should drive carefully and do not rely solely on the system. Before using the collision assist, the driver should check the restrictions they need to know by referring to this section.

# Starting and Driving

## Caution

The collision assist is designed to decrease the vehicle speed as much as possible to reduce the losses caused by collisions, instead of complete prevention of collisions. The driver should drive carefully and do not rely on the system.

When the system gives visual and audible warnings, the driver should immediately take further measures to avoid risk of collision and do not rely solely on the system.

The recognition range of front view camera realized by collision assist is limited, so you should not rely solely on the system to prevent collisions.

Due to the inherent limitations, the system may give a warning or brake when there is no risk of collision. The driver should always pay attention to the traffic environment ahead and take appropriate measures immediately.

The operating range of the collision assist system is 8km/h to 130km/h.

With the collision assist activated, if the "FCW (Forward Collision Warning)/AEB (Automatic Emergency Braking)

warning light (yellow)"  is always on, please go to our service dealer for repair.

## Service restrictions

- When the vehicle speed is lower than 8km/h, the system will not give alarm. The system triggered occasionally due to low vehicle speed in congestion road may provide poor driving experience.
- The driver shall ensure the seat belt is fastened properly, otherwise the AEM will not function.
- Please ensure the ESP (Electronic Stability Program) and collision assist function are on, otherwise the collision assist function will not function.
- Certain targets, such as highway barriers, tunnel entrances, heavy rain or ice, can affect or impair sensor detection, thus affecting AEB functions.
- The precondition for collision assist function to respond to the relevant target is that the target must be in the field of view of the sensor and be recognized. The collision assist function will be significantly limited with respect to cutting-in targets, those not detected until the current vehicle changes lane and those in the sharp turn road.
- The system will not respond to animals.
- Severe weather, such as wind, heavy rain, fog, etc., will affect the detection capability of the camera, which will reduce the system performance or increase the false trigger rate.
- For camera restrictions, see "Camera".

# Starting and Driving

---

## **LDW (Lane Departure Warning)**

LDW function provides assist for driver on expressway, fast roads and similar arterial roads. When the driver unintentionally departs from current lane, it will warn and prompt the driver to return to the original lane, avoiding the resulting traffic accident.

The LDW function will be enabled when the vehicle speed is higher than or equal to 60km/h and the road markings are visible. The system will not send alarm messages when the driver drives at low speed or takes active driving (judged by turning on direction indicator/changing lane in emergency).

### **Function on or off**

#### ***Function on mode***

Set in the entertainment system screen: Settings->Advanced Driver Assistance->LKA On.

#### ***Function off mode***

Set in the entertainment system screen: Settings->Advanced Driver Assistance->LKA Off.

When the function is deactivated, the "LDW (Lane Departure Warning)/LKA (Lane Keeping Assist)/ELK (Emergency Lane

Keeping) warning light (yellow)"  is always on.

### ***Audible alarm***

Set in the entertainment system screen, and click "...” button on the right of LDW, the options “ON” and “OFF” will pop up. The audible alarm function can be turned on or off.

### ***Sensitivity control***

Set in the entertainment system screen, and click "...” or ">” on the right of LDW, the options “Low”, “Standard” and “High” will pop up; you may select applicable sensitivity according to your needs.

### **Information prompt**

When the driver unintentionally departs from current lane, the system will remind the driver through the warning icon on the instrument cluster together with buzzer sound, and corresponding lane line on the instrument cluster is displayed in red. It means the vehicle is at the risk of lane departure, and the driver shall correct the vehicle to original lane in time.

# Starting and Driving

## Caution

LDW is only a driving function for alarm assistance.

The driver shall never fully rely on the LDW function to reminder of lane departure, but shall bear the responsibility of safe driving. LDW cannot function under all driving conditions or traffic, weather and road conditions.

When the lane keeping assist system fails, i.e. after the lane keeping assist function is activated, the "LDW (Lane Departure Warning)/LKA (Lane Keeping Assist)/ELK

(Emergency Lane Keeping) warning light (yellow)"  
is always on, please go to our service dealer for repair.



## Service restrictions

LDW cannot clearly detect the lane lines all the time. You may receive useless or invalid warning in the following conditions:

- Road construction areas, sharp turn or narrow roads.
- Dark (poor lighting) or weather conditions (due to heavy rain, snow, fog and wind). The recognition capability of the camera is deteriorated under direct sunlight or oncoming strong light.
- The camera's view is blocked by the large vehicle ahead or vehicle running nearby. The windshield in the camera's view is blocked (by water mist, dust or paster, etc.).
- The width and quality of lane lines are unsatisfactory, for example, the lane lines are worn and blocked, the new and old lane lines coexist, or change of lane lines in construction

sections. A large area of shadows are formed by the projection of trees, large objects or landscape features on the lane.

- LDW may miss warning or send incorrect warning in the following conditions:
  - For camera restrictions, see "Camera".
  - Weather conditions (heavy rain, snow, fog, extreme hot or cold temperature) interferes with camera operation.

The warnings and restrictions above do not cover all situations that may interfere with LDW. There are many factors that may disable LDW function. To avoid departure from the current lane, the driver shall keep alert, and pay close attention to the road conditions, so as to take corrective measures as early as possible.

2

# Starting and Driving

## LKA (Lane Keeping Assist)

When activated, LKA function will determine the position of vehicle relative to the lane lines based on the road boundary information acquired by the camera, and in combination of the vehicle state and the driver input, alarm the driver or return to the vehicle to the original lane by intervening the turning if the driver unintentionally departures from the lane. The function is a safety function, which corrects the vehicle when the vehicle is about to departure from the lane. It is not a comfort function of lane centering, etc., so the driver shall hold the steering wheel at the time.

The LKA function will be enabled when the vehicle speed is at 60km/h - 120km/h and the road markings are visible. The system will not send alarm messages or automatically intervene the turning when the driver drives at low speed or takes active driving (judged by turning on direction indicator/changing lane in emergency).

### Function on or off

The button for the LKA to be on or off is the same one as for LDW. See "LDW (Lane Departure Warning)" in this section for the operation mode.

### Information prompt

When the driver unintentionally departures from current lane, the system will remind the driver through the warning icon on

the instrument cluster together with buzzer sound, and may intervene the turning to return the vehicle to the original lane.

#### Caution

LDW is only a driver assistance function. The driver shall never fully rely on the LKA function to prevent the vehicle from departure of the current lane, but shall bear the responsibility of safe driving.

The driver shall observe traffic rules, and hold the steering wheel with both hands. If the driver has not held the steering wheel, the system will not provide the LKA function.

The LKA will not always help the driver correct the vehicle about to departure, and the driver must takeover the vehicle after LKA correction to ensure stable driving.

LKA cannot function under all driving conditions or traffic, weather and road conditions.

When the lane keeping assist system fails, i.e. after the lane keeping assist function is activated, the "LDW (Lane Departure Warning)/LKA (Lane Keeping Assist)/ELK

(Emergency Lane Keeping) warning light (yellow)"  is always on, please go to our service dealer for repair.

If the vehicle suspension suite after replacement has not approved by us, the LKA system may operate improperly.



## Service restrictions

LKA cannot clearly detect the lane lines all the time. You may receive invalid warning or false interference in the following conditions:

- Road construction areas, sharp turn or narrow roads.
- Dark (poor lighting) or weather conditions (due to heavy rain, snow, fog and wind). The recognition capability of the camera is deteriorated under direct sunlight or oncoming strong light.
- The camera's view is blocked by the large vehicle ahead or vehicle running nearby. The windshield in the camera's view is blocked (by water mist, dust or paster, etc.).
- The width and quality of lane lines are unsatisfactory, for example, the lane lines are worn and blocked, the new and old lane lines coexist, or change of lane lines in construction sections. A large area of shadows are formed by the projection of trees, large objects or landscape features on the lane.
- LKA may miss warning or send incorrect warning in the following conditions:
  - For camera restrictions, see “Camera”.
  - Weather conditions (heavy rain, snow, fog, extreme hot or cold temperature) interferes with camera operation.

The warnings and restrictions above do not cover all situations that may interfere with LKA. There are many factors that may disable LKA function. To avoid departure from the current lane, the driver shall keep alert, and pay close attention to the road conditions, so as to take corrective measures as early as possible.

## ELK (Emergency Lane Keeping)

When the ELK (Emergency Lane Keeping) function is activated, it determines the position of the vehicle relative to the adjacent vehicle or curb, etc. based on the road environment information obtained by the front cameras and corner millimeter wave radars, and will warn the driver or keep the vehicle away from the risk of collision by steering intervention in combination with the vehicle status and driver input if the driver departs unintentionally, causing risk of collision with the adjacent vehicle or curb, etc. This is a safety function, not a comfort function.

The lane keeping function is activated when the vehicle speed is between 60km/h and 120km/h and the road markings are clearly visible.

When the vehicle is driven at low speed or actively (judged by rapid lane change, etc.), the system will not give an alarm or automatically intervenes in steering.

### Function on or off

The button for the ELK to be on or off is the same one as for LDW. See “LDW (Lane Departure Warning)” in this section for the operation mode.

### Information prompts

When the driver departs unintentionally and there is a risk of collision with the adjacent vehicle or curb, etc., the system will remind the driver through the warning icon on the instrument cluster and the sound of the buzzer, and may intervene in

# Starting and Driving

steering to keep the vehicle away from the adjacent vehicle or curb, etc. to avoid the risk of collision.

## Caution

The emergency lane keeping assist is just a driver assistance function. The driver should not rely solely on the emergency lane keeping function to prevent collision with the adjacent vehicle or curb, and should bear the responsibility for safe driving.

The driver should follow the traffic regulations and hold the steering wheel firmly with both hands. If the driver does not hold the steering wheel, the system will not provide the emergency keeping assist function.

The emergency lane keeping assist will not always help the driver correct the vehicle with a tendency to collide with the adjacent vehicle or curb, and the driver must take over the vehicle after correction to ensure that the vehicle is stable.

The emergency lane keeping assist cannot work under all driving or traffic, weather and road conditions.

When the emergency lane keeping assist system fails, i.e. after the lane keeping assist function is activated, the "LDW (Lane Departure Warning)/LKA (Lane Keeping Assist)/ELK

(Emergency Lane Keeping) warning light (yellow)"  remains on, please drive to Our Service Dealer for service.

## Caution

If the vehicle suspension kit replaced by yourself is not approved by us, the emergency lane keeping assist system may not operate properly.

## Usage restrictions

The emergency lane keeping assist cannot clearly detect lane lines at all times. You may receive invalid warning or false interference under the following conditions.

- In road construction areas, at sharp turns or on narrow roads.
- Darkness (poor lighting) or weather conditions (due to heavy rain, heavy snow, dense fog or high wind).
- The recognition capability of the camera is deteriorated under direct sunlight or oncoming strong light.
- The lateral vehicle is large or the vehicle appearance is irregular, and the curb is severely damaged or unconventional, so that the cameras cannot accurately identify it as the object to be avoided.
- Camera view blocked (water mist, dust, or sticker, etc.).
- The width and quality of lane lines fail to meet the requirements, such as lane lines worn or covered, presence of both old and new lane lines, or lane lines changed by construction sections.
- Large shadows are projected on the lane by trees, large objects, or landscape features, etc.
- The emergency lane keeping assist may miss a warning or give a false warning under the following conditions:

- See "Camera" for camera restrictions.
- Weather conditions (heavy rain, snow, fog, extremely high or low temperatures) interfere with camera operation.

The above warnings and restrictions do not include all conditions that may interfere with emergency lane keeping assist. Many factors may cause the emergency lane keeping assist to be inoperative. In order to avoid the risk of collision with the adjacent vehicle or curb, the driver should remain vigilant and always pay attention to the road conditions, so that corrective measures are taken as soon as possible.

## **SLIF (Speed Limit Information Function)**

SLIF (Speed Limit Information Function) is to use intelligent front view camera or maps to recognize speed signs and send relevant information to the instrument cluster, in order to remind the driver of the speed limit information on the current road and prevent overspeed. In this case, the system will not actively adjust the speed, and the driver should actively control the speed.

2

### **Function enable/disable**

Set it in the central control screen: Settings -> Advanced driver assistance -> Speed limit information function, and select: enable/disable the SLIF.

### **Activation conditions**

- The sensor signal is normal (camera).
- The speed limit sign is detected.
- The front view camera module at the front windscreen is not blocked/fogged, etc.

### **Alarm sound settings**

Set it in the central control screen: Settings -> Advanced driver assistance -> Enable speed limit information function -> More -> Turn on or off the prompt tone.

### **Message prompt**

After the function is enabled, if a speed limit sign is recognized, and the current vehicle speed is less than the speed on the

# Starting and Driving

speed limit sign, the instrument cluster will display the current speed limit value.

When a new speed limit sign is recognized, a "tick" reminder sound will be given first before the change of speed limit sign.

When the current vehicle speed is detected to be greater than the speed on the speed limit sign, the indicator corresponding to the speed limit sign will flash, accompanied by an audible alarm.



It indicates the speed limit value of the current road.

## Caution

When the system can not recognize the speed limit sign information ahead, the instrument cluster will not display the speed limit sign information.

The system only prompts the speed limit information, without controlling the speed of the vehicle.

The system's recognition of speed limit signs is not completely accurate. For false recognitions, the driver should drive cautiously according to the actual road conditions.

## Use restrictions

The traffic sign information function only works when the speed sign is clearly visible. It cannot work properly or may be inoperative in some circumstances. For example:

- The speed limit signs are in poor condition, such as faded, located on a curve, placed at an improper angle, rotated or

damaged, completely or partially covered, too far or too high, and attached to road surfaces.

- The detection range of the camera is blocked when the vehicle runs too close to the vehicle ahead.
- The road or speed limit is changed recently, such as construction, traffic control, etc.
- Some LED speed limit signs.
- See "Camera" for camera restrictions.
- SLIF performance is limited by map coverage, which only covers the EU region.

**Note: To ensure the performance of SLIF (Speed Limit Information Function), please upgrade your offline map in a timely manner so that the current time does not exceed one year after the offline map version was released. Method for viewing offline map version: Go to the Head Unit - System Information to view the offline map version number, for example, the version number EU\_ AL\_ 20230216 indicates that 20230216 is the version release time.**

## Tires



### **DEFECTIVE TIRES ARE DANGEROUS!**

**Do NOT drive your vehicle if any tire is excessively worn or damaged, or is inflated to an incorrect pressure.**

**Do NOT overload vehicle.**

Incorrect tire inflation pressures or an unbalanced wheel and tire assembly can seriously affect stability, especially when driving with high payloads or at high speeds. Under-inflation also increases rolling resistance which accelerates tire wear and causes tire damage which can lead to an accident.

Always drive with consideration for the condition of the tires; the most common causes of tire failure are:

- Bumping against kerbs.
- Driving over deep pot holes.
- Driving with under or over-inflated tires.

Uneven tread wear can be caused by faulty wheel alignment.

## Winter tires



**The vehicle speed shall not exceed the maximum allowable speed of the installed winter tires, otherwise the tires may suddenly lose pressure, delaminate, or even burst, which may easily cause accidents!**

**Be sure to adjust the speed according to the specific climate, roads and traffic conditions. Do not take risks by taking advantage of the anti-skid performance provided by winter tires and beware accidents!**

Winter tires can improve the handling stability and braking performance of the vehicle when driving in a low temperature environment or on icy roads. It is suggested that winter tires should be used when the temperature is lower than 7°C.

When a vehicle is running under winter road conditions, winter tires can greatly improve the handling stability and braking performance. Non-winter tires have poor skid resistance at low temperatures or on icy roads due to their structure (tire width, rubber composition, pattern type, etc.).

It is recommended to use winter tires of the same size and load index as that of the original tires, and all the four wheels shall use winter tires.

When the tread depth of winter tires is worn to 4mm, the skid resistance will decrease obviously.

# Starting and Driving

---

When the temperature rises above 7°C, it is recommended to replace winter tires with non-winter tires.

## Anti-skid chain

When driving vehicle on the snow, it is recommended applying S anti-skid chain to the driving wheels.

Anti-skid chain could increase the traction when driving on road in the winter. If you want to install the anti-skid chain, please remember that:

- 1 Not all wheels and tires are suitable for anti-skid chain.  
When installing anti-skid chain, only approved tire size can be used.
- 2 Apply anti-skid chain to the driving wheels. Please follow the instructions of anti-skid chain manufacturer.

It is just on the snow that you can drive the vehicle at maximum speed allowed by the anti-skid chain. Please follow the regulations in your country. Remove the anti-skid immediately when on the snow-free road.

## Loading

Each driver is obliged to ensure his vehicle is free of overload.

**Note: The maximum allowed total mass is indicated on the vehicle identification plate which is located in the lower front of right B-pillar. This handbook introduces the correct vehicle weight parameters, see "Vehicle weight parameters".**

## Load carrying

Goods shall be placed between both axles and neither deviate to the front axle loading area nor the rear axle loading area. Heavier goods shall be distributed evenly, and the heaviest goods shall be placed between both axles.

# Starting and Driving

## Load restraint

**!** Secure all loads in the vehicle to prevent personal injury due to movement of load.

**Note:** *It is the driver's responsibility to ensure that loads are properly secured.*

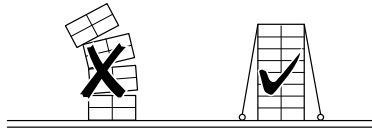

## Load restraint assemblies

A lashing ring is mounted on the side wall of the cargo compartment for cargo restraint.

Please use it with the webbing. Pay attention to the strength of the webbing to be used. The maximum bearing capacity of a single lashing ring is 5000N.

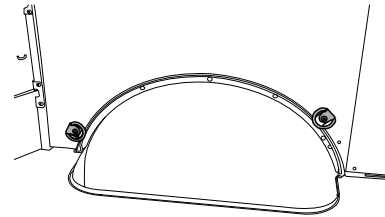

2

## Partition

**!** As the partition is not designed to restrain loads, loads shall be secured properly against movement.

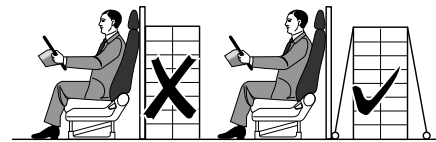

# Starting and Driving

---

## Trailer towing

**Note: It is applicable to the vehicle equipped with the trailer device.**

The vehicles are designed for use primarily as a passenger and load bearing vehicle. Towing a trailer may create adverse effects on a number of factors including handling, durability, performance and braking. We recommend for the safety of yourself, your passengers and others that the vehicle and trailer is not overloaded.

The warranty does not cover any damages caused by or relating to towing a trailer.

- Weight limits

Establish that gross vehicle weight, trailer tow ball down load, trailer weight and axle weights are all in accordance and not exceeding their individual limits.

- Gross Vehicle weight

Please refer to your vehicles data label for reference on what gross vehicle weight must not be exceeded.

Gross vehicle weight is the combined weight total of the trailer towbar, unloaded vehicle, driver, luggage and passengers. This also includes the weight of any accessories or equipment added to the vehicle.

### Instructions before use

- The state specific trailer towing regulations must be followed.
- The vehicle speed should not exceed 70 kilometers an hour.

- It is only applicable to center axle trailers, and the load specified in "Recommended towing weight" shall not be exceeded when towing trailers.
- When a new vehicle has been driven or a vehicle has had powertrain parts changed to new parts, it is recommended not to tow a trailer until the driving distance reaches 800 km.
- Place the load as close as possible to the trailer axle, fix it securely and place it as low as possible, while ensuring that the towing weight and the load allowed by the tow ball are not exceeded (See "Recommended towing weight" for details). For best stability of the trailer in an unladen vehicle, place the load in the trailer towards the nose within the maximum nose load (See "Recommended towing weight" for details), as this gives the best stability.
- The specified trailer loads are only applicable to an altitude less than 1,000 m. As the air density decreases with the altitude increase, causing the drive power output and grade ability to drop, the total mass must be reduced by 10% when the altitude increases by 1,000 m.
- The tires of towing vehicle shall be adjusted to the specified pressure, and the pressure of trailer tires shall also be checked, and on the rear tire pressure, at least 20kPa(0.2bar) above the tire pressure as recommended for normal use(i.e. without a trailer attached).
- If the traffic conditions behind the trailer are invisible through the standard outside rear view mirrors, two additional rear view mirrors must be installed on the reversible boom and adjusted to ensure sufficient rear view at any time.



# Starting and Driving

---

- The headlamps shall be checked and adjusted if necessary after a trailer is hitched up.
- Always use a safety chain that is suitable for your vehicle and trailer. Have the safety chain passing through the hole at the lower part of the hitch and attach it to the trailer. The safety chain will prevent the trailer from dropping to the ground in the event that the hitch disengages. For proper use and installation, consult the trailer manufacturer.

## Instructions for driving

- Before driving, check all the safety equipment to ensure safe operation. Ensure that the vehicle is properly maintained to avoid mechanical failure.
- Avoid non-loaded towing vehicle and loaded trailer as much as possible when driving. If it is inevitable, drive at low speed due to improper load distribution.
- As the driving stability of towing vehicle and trailer drops with the speed increase, the speed shall be as low as possible without exceeding the specified speed limit under the improper road, weather and strong wind conditions, especially when driving on a slope.
- When the trailer sways, grip the steering wheel firmly to drive straightforward, and release the accelerator pedal to decelerate the vehicle slowly. Do not attempt to eliminate sway by turning the steering wheel or by emergency braking. The higher the speed, the stronger the trailer swaying. If the sway is still not eliminated after deceleration, stop the vehicle

to check if the trailer weight distribution is even and the trailer device is installed securely.

- Under any conditions, the vehicle must be decelerated immediately once minor sway is noticed on the trailer, and never try to eliminate the sway through acceleration.
- If an inertia brake is installed on the trailer, first brake slowly and then brake rapidly when braking is required. This can avoid braking impact due to trailer wheel locking. When driving on a slope, shift to a lower gear immediately to make full use of engine braking action.
- Clean, dry and flat concrete or asphalt (or similar) pavement is required for towing, and the maximum climb grade for continuous towing is 12%.

2

## Starting and Driving

---

### Recommended towing weight

#### Towing capacity

Model	GVW(kg)	CVW(kg)	ATM(kg)- unbraked trailer	GTM(kg)
Short wheelbase van, 50kWh high-voltage battery pack model	2660	1615	750	2750
Long wheelbase cab, 50kWh high-voltage battery pack model	2920	1515	750	3100

#### Caution

- The sum of the total mass of the towing vehicle and the total mass of the trailer shall not exceed the specified gross train mass (GTM) of the vehicle.

# Starting and Driving

## Trailer nose weight

### Caution

The technically permissible maximum mass at the coupling point shall not be less than 4% of the maximum permissible towable mass and not be less than 25kg. Never exceed the maximum allowable nose weight, such as the vertical weight on the ball of the trailer. This is very important for the stability of the vehicle and trailer. The maximum nose weight is  $\leq 10\%$  \*ATM.

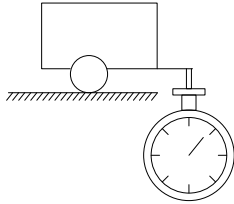

Variant	Maximum nose weight
All models	75kg

## Installation of trailer device

The class of the coupling ball is A50-X. Users can match and install the corresponding trailer according to their needs. If you need to install trailer devices, please contact our Service Dealer.

## Maintenance

If the vehicle is often used to tow a trailer, additional maintenance shall be made in the maintenance intervals to ensure continuous satisfaction for the vehicle.

2



## **Emergency Troubleshooting**

- 118 Hazard light
  - 118 Warning triangle
  - 119 Self-service tire repair
  - 125 Wheel replacement
  - 130 Towing
  - 132 Jump start
  - 133 Replacing fuse
  - 139 Replacing bulbs
-

# Emergency Troubleshooting

---

## Hazard light

When your vehicle needs to stop or slow down, press hazard light switch  in the middle of the instrument panel to light on 'direction indicator (green)' on the instrument cluster and flash all turn signal lights, warning others and making the police know you are in trouble.

## Warning triangle

Warning triangle is placed between the driver's seat bracket and the cargo compartment partition.

If you have to pull the vehicle over, you need to place a warning triangle about 100m right behind the vehicle to warn other vehicles incoming.

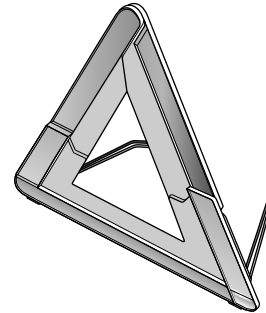

# Emergency Troubleshooting

## Self-service tire repair

**Note:** *It applies to the vehicles equipped with tire repair kit.*

### Precautions

**!** The main composition of this tire sealant is natural latex. Do not eat it. Do not inhale or swallow it. If accidentally ingested, go to the hospital immediately. Do not induce vomiting. Avoid contact with the skin or eye, otherwise it may cause skin or eye discomfort. In case of accidental contact with skin, rinse thoroughly with water and soap. If the tire sealant accidentally enters the eye, rinse immediately with clean water. Keep this product out of the reach of children. Follow the Road Traffic Safety Law and other laws and regulations when using this product.

- Read this instruction carefully before using the product.
- After repairing the leaking tire with this product, the vehicle speed should be kept within 80 km/h.
- When using this product to repair the leaking tire, since the leaking tire still has a certain pressure, some sealant may leak out from the hose at the time of connection with the tire; this is normal. This product is made of natural rubber, which is the same as the raw material of the tire. It has no damage to the tire and the wheel hub. It can be used in the range of ambient temperature from -40°C to 80°C. The vehicle should

be checked and repaired at our Service Dealer as soon as possible after the completion of running.

### Tire repair kit

Driver's tool package is located under the driver's seat.

### Tire inflator

- Inflator upper surface

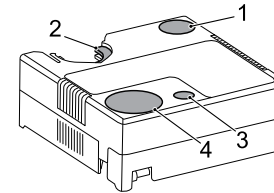

- 1 Power switch (black)
- 2 Sealant can bayonet
- 3 Relief valve switch (yellow)
- 4 Tire pressure gauge

# Emergency Troubleshooting

- Inflator bottom surface

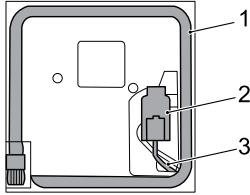

- 1 Inflation tube
- 2 Power plug
- 3 Power cord

## ***Tire sealant can***

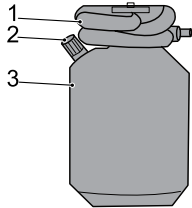

- 1 Sealant tube
- 2 Inflation tube fitting
- 3 Can body

## **Usage**

The tire repair tool has the function of repairing the leaking tire, detecting the tire pressure and inflating and deflating the tire.

Before using this product, please complete the following preparations:

- 1 Park the vehicle in a safe place.
- 2 If a tire leaks during the running of the vehicle, a warning sign should be placed at a safe position to avoid accidents.
- 3 Identify the leaking tire and the cause of the tire leak, and then inflate or repair it according to the operation methods of tire inflation or tire repair in this instruction.
- 4 Confirm that the tire sealant can and the inflator are the original products of our company, otherwise it may cause adverse or even dangerous consequences such as air leakage and sealant spraying. Ensure that all parts of the product are in good condition before use.
- 5 Check that the can is filled with tire sealant before using this product to repair the leaking tire.



# Emergency Troubleshooting

## Operation method of tire repair

- 1 Verify that the switch is off. Release the tube from the sealant can, push the can port horizontally into the can bayonet on the inflator, and then connect the inflation tube to the can.

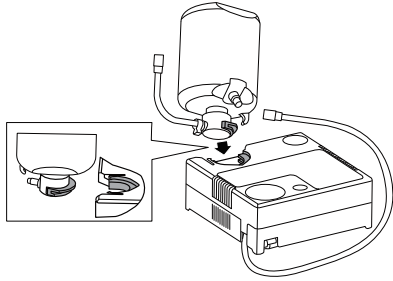

- 2 Connect the sealant tube to the leaking tire.

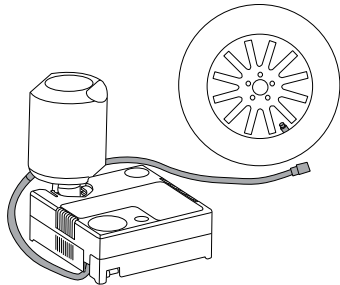

- 3 Insert the inflator power plug into the on-board power outlet, and start the vehicle.

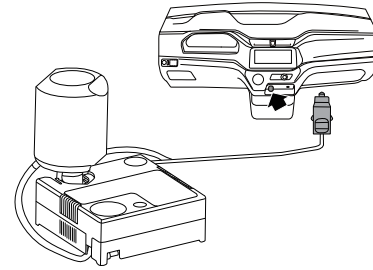

- 4 Turn on the power switch (black) to inject sealant into the tire. The value on the tire pressure gauge rises first, and then slowly drops to the leaking tire pressure. When the pressure reaches the recommended value (refer to "Wheels and tires"), turn off the power switch, pull out the sealant tube, the inflation tube and the power plug in sequence.

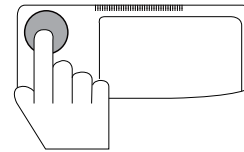

3

# Emergency Troubleshooting

- 5 Restart the vehicle to travel 3 ~ 5 km at a speed lower than 30 km/h.

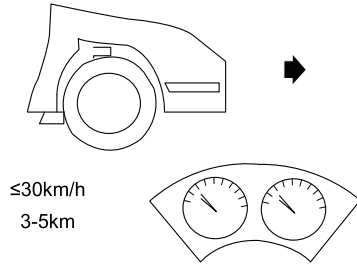

- 6 Park the vehicle in a safe place, and connect the inflation tube to the tire again.

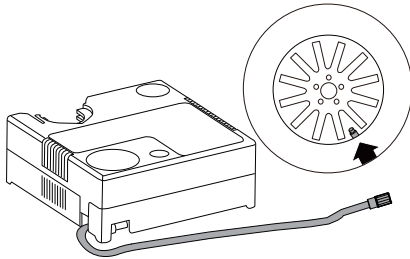

- 7 Observe the pressure value; if there is a significant decrease, conduct the tire inflation operation. Then drive 3 ~ 5km and check the tire pressure (if the tire pressure still drops significantly, the tire is seriously damaged and beyond the scope of use of this product, please call for rescue).

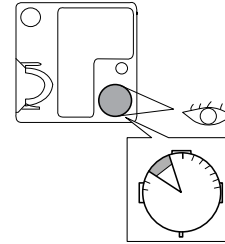

- 8 Remove the "80" sticker from the can and attach it to the steering wheel to remind the driver that the speed should be kept within 80 km/h after using the product.

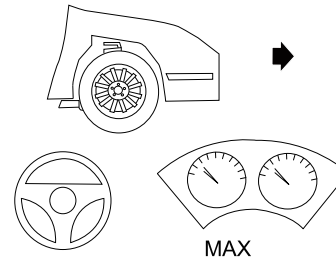

# Emergency Troubleshooting

## Operation method of tire pressure detection

1 Take out the inflation tube and connect it to the tire.

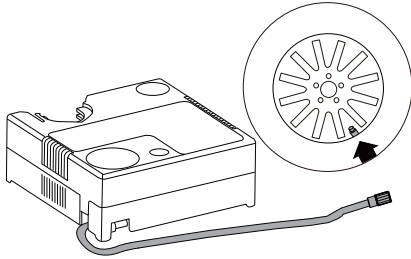

2 Insert the inflator power plug into the on-board power outlet, and start the vehicle.

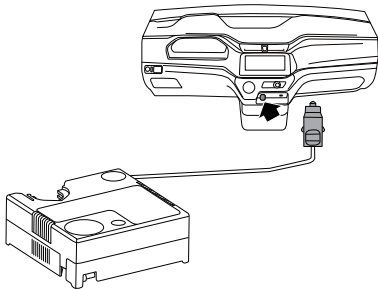

3 Turn on the power switch (black) to inflate the tire. Observe the tire pressure gauge; when the pressure reaches the recommended value (refer to "Wheels and tires"), turn off the power switch, and pull out the inflation tube and the power plug.

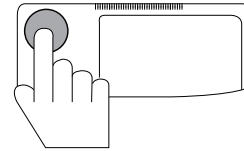

3

## Operation method of tire pressure relief

1 Take out the inflation tube and connect it to the tire.

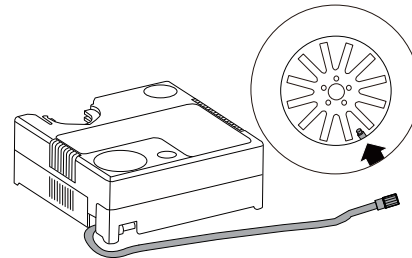

## Emergency Troubleshooting

- 2 Press the relief valve switch (yellow) and observe the tire pressure gauge until the tire pressure is reduced to the desired value.

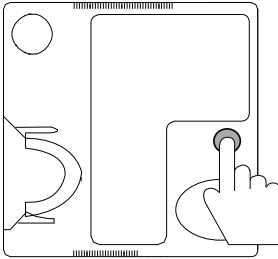

**Note:** After using this product, you should go to our Service Dealer for tire repair as soon as possible. Since some sealant may remain in the tire, in professional repair, it is recommended that the tire be placed horizontally on the level ground for drainage, and it will be better to place a small piece of cloth on the tire valve core for the avoidance of a small amount of sealant splashing. If you accidentally drop the tire sealant on the floor or other items, just wipe it off with a rag and then wash it with clean water. The tire sealant is made of natural latex and will not cause any corrosion or other negative effects on the wheel hub and the tire.

### Caution

- Use a can of this product to repair a tire.
- In order to ensure the effect of this product, it is better not to remove the thorns on the tire; if they are removed, the effect will not be affected.
- Do not disconnect the sealant tube from the tire directly during use. After the completion of tire repair, turn off the switch and then remove the tube from the tire.
- When using this product, the vehicle needs to be started to supply power. Therefore, pay attention to using the auxiliary brake (i.e. apply the handbrake) in advance to prevent the vehicle from moving and causing personal and property damage.
- Store the product in a cool, dry place, away from fire. Try to bring the product with the moving vehicle to better ensure the quality of the tire sealant.
- There is no side effect on the tire after using this product.
- When using this product, the inflation tube may be hot due to the compression of the air; this is normal.

# Emergency Troubleshooting

## Wheel replacement

*Note: It applies to the vehicles equipped with spare tires.*

### Jack

#### Placement

The jack is located under the driver's seat.

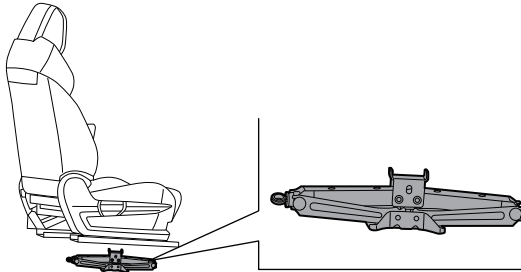

#### Specifications



**This jack is just for wheel replacement. Never use it for other purposes.**

**This jack is just for your vehicle and never uses it for other models.**

## Spare tire



**Regularly check the air pressure of spare wheel. The use of a spare wheel with incorrect tire pressure will affect wheel stability, which may lead to dangerous consequences and will cause permanent damage to the tire.**

The spare tire is mounted at the rear bottom of the body; the wheel nut wrench and the auxiliary rotary extension rod in the vehicle tool kit can be used to rotate the pillar bolt of drive mechanism, thus releasing or tightening the rope for the spare tire to achieve the function of spare tire replacement.

### Removing spare tire

- 1 Take out the vehicle tools under the driver's seat. Rotate the jack mounting screw to take out the jack.

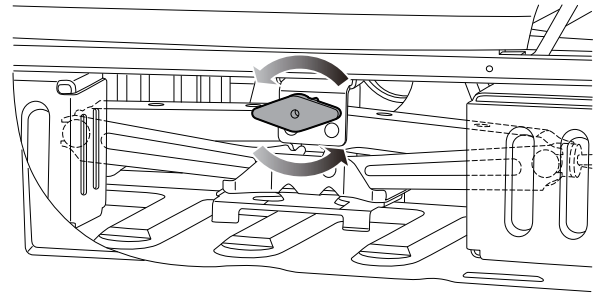

## Emergency Troubleshooting

- 2 Mount the auxiliary rotary extension rod and the wheel nut wrench.

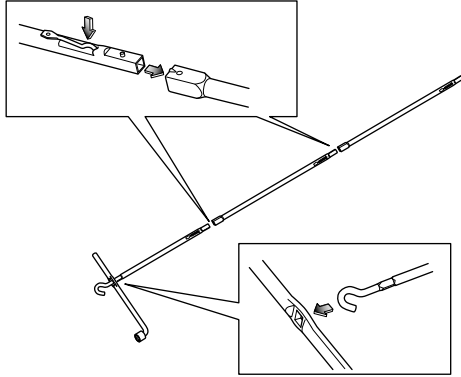

- 3 Put the auxiliary rotary extension rod through the rear bracket hole and the guide sleeve of the spare tire device, and insert it into the spare tire loading and unloading hole. Then rotate the wheel nut wrench counterclockwise to lower the spare tire till the wheel lands on the ground.

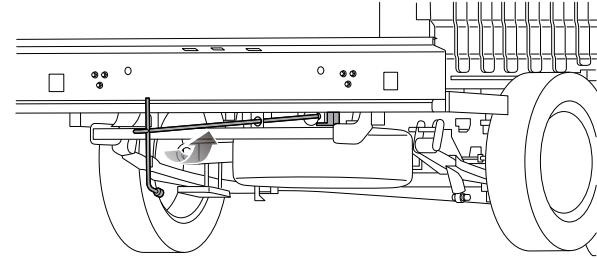

- 4 After the spare tire reaches the ground, continue to turn the wheel nut wrench counterclockwise and pull out the spare tire. Excessive rotation of the wrench is prohibited, or the spare tire device will be damaged.
- 5 Remove the tray from the spare tire.

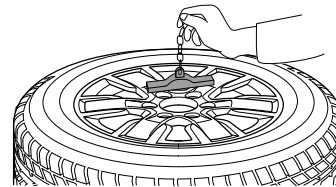

# Emergency Troubleshooting

## Caution

After the spare tire is replaced, be sure to place the replaced wheel back to the spare tire position, lift and tighten it, otherwise it may cause the wire rope to stagnate in the next use after the wire rope is retracted under no-load condition, thus leading to the failure to lower the spare tire smoothly. If the replaced wheel is not placed back to the spare tire position, it is necessary to have a person under the vehicle keep pulling the spare tire during the lifting process of the spare tire, to avoid wire rope stagnation. Be sure to fully lift and tighten the spare tire.

## Storing the spare tire

- 1 Put the wheel on the ground, with the tire valve up (be careful not to reverse it).
- 2 Place the wheel at the rear bottom of the vehicle.
- 3 Place the spare tire tray in the center of the rim, and adjust it to the proper position to make it tightly connected to the spare tire.

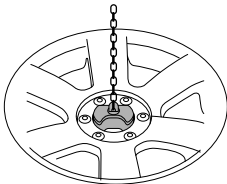

- 4 Rotate the wheel nut wrench clockwise until a click sound is heard, indicating that the spare tire is installed in place.

## Caution

After placing the wheel on the spare wheel holder, check whether the wheel mounting is tight. If the wheel is loose, it may fall off owing to vibration and cause an accident.

# Emergency Troubleshooting

## Replacing tire

### Vehicle parking

**!** Park your vehicle in firm and level ground without disturbing traffic or traffic hazard to yourself.

If on the public road, please turn on hazard warning light and position a warning triangle.

Ensure that the ground where the jack is located is firm enough to support the jack and the vehicle to be lifted; otherwise it will move for instability, causing damage to the vehicle and/or personal safety.

Secure other wheels with proper wheel stoppers.

Never use jack if the ground is sloping. If jack is unsuitable to use or you are unsure to complete the task safely, please ask for assistance.

Front wheels must be straight-ahead.

While switching off the motor, apply the parking brake and place the shift lever in P position.

### Positioning jack

**!** Only use jack at specified jacking points. The lifting height shall not be more than the height necessary for tire replacement (such as no more than 30cm above the ground).

**!** Before using the jack, ensure all passengers have left the vehicle.

No person should place any portion of their body under a vehicle that is supported by a jack.

The jack shall be perpendicular to the vehicle body while lifting.

The jacking points are located on the side skirt, the jacking points for front wheels are located behind the front wheels, and those for rear wheels are located in front of the rear wheels. Secure the skirt metal plate in the slot on the jack head.

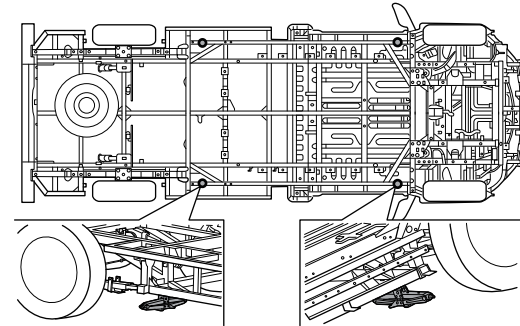



# Emergency Troubleshooting

## Replacing with spare tire



Never start the vehicle while lifting. Never walk under the lifted vehicle. Before removing the wheel nut, make sure the vehicle is stable and will not slide or move. Torque wrench shall be used to check exact tightened torque of wheel nuts and tire pressure as soon as possible after replacing the wheel.

Replaced wheel, jack and vehicle tool kit must be stored in specified location. Otherwise they may cause damage or personal injury during impact or heavy braking if casually or improperly placed.

- 1 Remove the spare tire (See "Spare tire" in this section).
- 2 Check whether the jack is still perpendicular to the jacking points; Change position when necessary.
- 3 Use the wheel nut wrench in the vehicle tool kit to loosen the wheel nut counterclockwise.
- 4 Mount the auxiliary rotary extension rod and then rotate the wheel nut wrench clockwise till the wheel to be replaced gets off the ground.
- 5 Remove the retaining nuts of the wheel and then carefully remove the wheel.
- 6 Replace it with the spare wheel and then tighten the wheel nuts clockwise.
- 7 Lower the vehicle body and remove the jack.
- 8 Fully tighten the retaining nuts of the wheel in a diagonal order (see the diagram); the wheel nut torque is  $125\pm 13\text{Nm}$ .

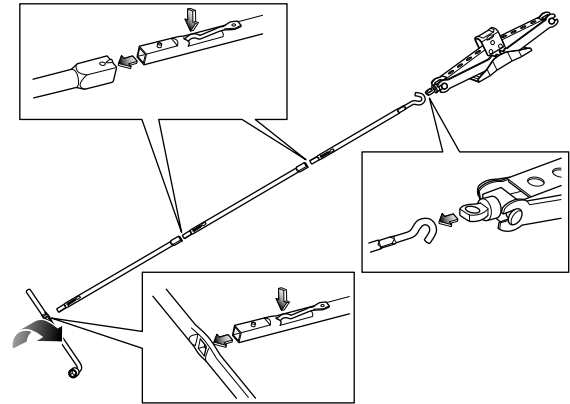

# Emergency Troubleshooting

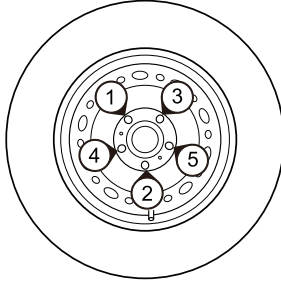

- 9 Mount the replaced wheel into the position of spare tire, see "Storing the spare tire" in this section.
- 10 Put away the replaced wheel, wheel nut wrench, the auxiliary rotary extension rod, jack and vehicle tool kit.

## Caution

After the spare tire is replaced, be sure to place the replaced wheel back to the spare tire position, lift and tighten it, otherwise it may cause the wire rope to stagnate in the next use after the wire rope is retracted under no-load condition, thus leading to the failure to lower the spare tire smoothly. If the replaced wheel is not placed back to the spare tire position, it is necessary to have a person under the vehicle keep pulling the spare tire during the lifting process of the spare tire, to avoid wire rope stagnation. Be sure to fully lift and tighten the spare tire.

## Towing

While being towed, relative national regulations about vehicle towing shall be abided by.

**!** Informing the rescue personnel that the vehicle being towed is a battery electric car before towing. Please read the on-board rescue information card. Remove the key before towing and disconnect the MSD on the high-voltage battery pack throughout the towing.

## Towing hitch

If this vehicle is to be towed from the front, pry off the towing hitch plug from the right side of the front bumper, and then tighten the front towing hitch originally stowed in the tire repair kit to the right side of the front bumper.

Unscrew the towing hitch after the towing operation is done, and secure the towing hitch plug onto the right side of the front bumper.

# Emergency Troubleshooting

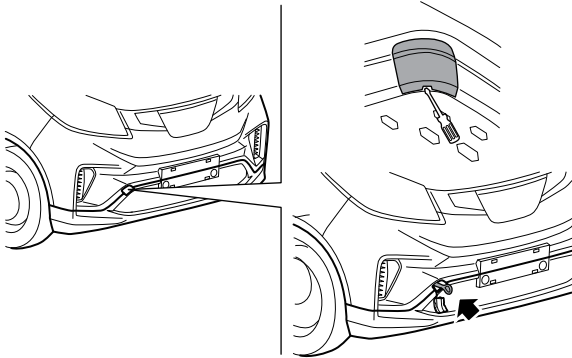

## Caution

Do not tow the vehicle with its front wheels on the ground or using a plate trailer directly. When loading the vehicle onto the towing vehicle or unloading it from the towing vehicle, with the vehicle's front wheels on the ground, the speed shall not be higher than 5 km/h. When the vehicle is being towed with its front wheels off the ground, the towing speed shall not be higher than 30 km/h and the towing distance shall not exceed 50 km. This vehicle shall not be used to tow other vehicles. Do not carry out towing in reverse or it will damage the planetary gear mechanism in the electric drive system.

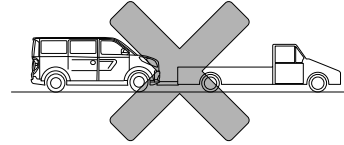

DO NOT tow the vehicle with its front wheels on the ground

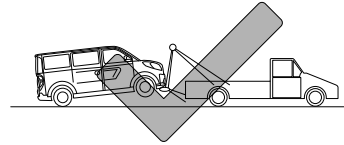

Towing the vehicle with its rear wheels on the ground is allowed

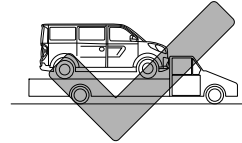

Towing the vehicle with its front wheels off the ground is allowed

# Emergency Troubleshooting

## Jump start

### Battery disconnection

**!** Always wear protective gloves and eye protecting glasses when working on a battery. Do not use naked light, cause sparks or smoke in the area of the battery. You can be seriously injured and the vehicle damaged.

Disconnect battery, negative (-) earth terminal first and then positive (+). Connect battery, install and secure positive cable (+) first and then negative (-) cable. Smear the terminals with petroleum jelly.

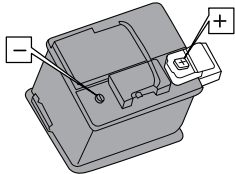

### Caution

Before disconnecting the battery, always switch off the motor and all electrical appliances for more than 2 minutes. While disconnecting, never allow the terminal to contact the metal parts of vehicle body. Otherwise short circuit may cause electric spark. Electrical system may be damaged if connecting positive and negative cable reversely.

## Jump start

**!** Never pull or tow the vehicle to start.  
**!** Ensure the rated voltage of two batteries is the same (12 V) and the jumper cable is acknowledged as the cable used for 12V vehicle battery.

### Jumper

- Pull two vehicles together as possible.
- Switch off all electrical equipment.
- Connect the positive terminals (+) of two batteries with red jumper cable.
- Connect black jumper cable from power supplying battery negative terminal (-) to earth point (not negative terminal) of battery that need to be powered.
- Ensure all connection mechanisms are well connected.
- Check that the jumper cable clear of any moving parts when the motor starting.
- Check that the handbrakes of the two vehicles are applied and gear lever is in position 'P'.

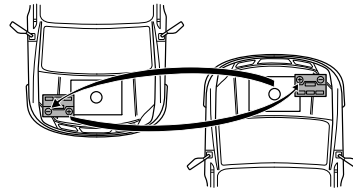

# Emergency Troubleshooting

## Starting

Start the vehicle whose battery supplies power and allow it to run for several minutes.

- Start the vehicle whose battery needs to be powered.
- After starting the vehicle, allow it to run for two minutes above.

**Note: If it fails to start after several attempts, the vehicle may need maintenance.**

**Note: If the malfunction indicator lamp appears on the instrument cluster after starting up the vehicle, it may be due to low battery voltage. Please try to power off and power on the vehicle after the battery voltage is stable (the vehicle can be started on its own without jump start). If the malfunction indicator lamp on the vehicle's instrument cluster remains on after several attempts, the vehicle is likely to need repairing. Please contact our Service Dealer for repair.**

## Disconnecting

- Switch off the engine or drive motor of the vehicle that supplies power.
- Ensure the cable terminals shall not contact with each other.
- Remove the jumper cable. Removal is the reverse of connection.

### Caution

Before removing the jumper cable, never turn on any electrical equipment of the vehicle started.

## Replacing fuse

Fuses of this vehicle are located in three boxes.

### Caution

Spillage of liquid to any electric components in the vehicle may damage the components, so it is required to cover any electric components. The content of the fuse specification list according to the vehicle configuration and technical status will be constantly updated, please refer to actual state of your vehicle.

# Emergency Troubleshooting

## Driver compartment fuse box

Driver compartment fuse box is located behind the lower storage box at the driver side.

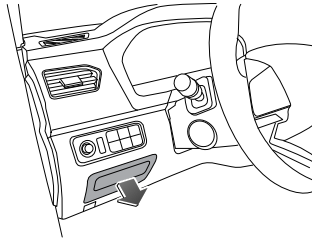

Fuses in the driver compartment fuse box can be identified with labels on the back of the lower storage box cover at the driver side.

### Specifications of driver compartment fuse

Fuse	Specs	Function
IF01	5A	Power switch
IF02	10A	Data Link Connector (DLC)
IF03	25A	Entertainment system mainframe
IF04	5A	Remote monitoring module/rear view camera
IF05	5A	Shifter control unit
IF06	/	Reserved

Fuse	Specs	Function
IF07	10A	Front A/C control panel/entertainment system display
IF08	5A	Instrument cluster
IF09	15A	Radio
IF10	/	Reserved
IF11	/	Reserved
IF12	/	Reserved
IF13	10A	Airbag controller
IF14	5A	Instrument cluster
IF15	5A	Shifter control unit
IF16	5A	Electric power steering
IF17	10A	Front A/C control panel
IF18	5A	Dimmer switch/PTC thermostat
IF19	5A	Remote monitoring module
IF20	/	Reserved
IF21	5A	Driver window regulator switch/Front occupant window regulator switch/radio
IF22	5A	USB charger
IF23	20A	12V power outlet
IF24	10A	Power rearview mirrors
IF25	/	Reserved
IF26	/	Reserved

# Emergency Troubleshooting

Fuse	Specs	Function
/	Reserved /	
/	Reserved /	
/	Reserved /	

## Front compartment fuse box

Front compartment fuse box is located at the right of compartment wall at the front hood bottom (viewed from the front of vehicle).

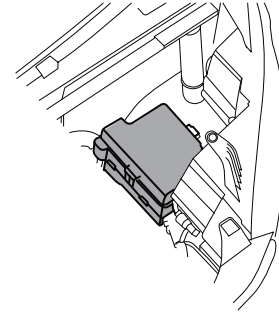

3

### Caution

Before opening the fuse box cover, make sure its surroundings are dry and no fluid flow from any direction into the opened fuse box, otherwise the fuse box will be damaged, leading to serious consequences.

## Emergency Troubleshooting

Fuse can be accessed by just removing the cover of front compartment fuse box. Fuses in the front compartment fuse box can be identified by the label printed at the back of the fuse box cover.

### Specifications of front compartment fuse

Fuse	Specs	Function
UF01	30A	In-car fuse box constant power supply fuse 1
UF02	30A	In-car fuse box constant power supply fuse 2
UF03	30A	Main relay power supply
UF04	30A	ACC relay power supply
UF05	30A	Blower
UF06	30A	IG relay power supply
UF07	40A	ABS
UF08	30A	Electronic vacuum pump
UF09	30A	Cooling fan
UF10	/	Reserved
UF11	/	Reserved
UF12	15A	Washer motor
UF13	15A	Electric horn
UF14	20A	BCM_SPOC
UF15	25A	BCM_door lock motor

Fuse	Specs	Function
UF16	15A	BCM_exterior light power supply 1
UF17	25A	BCM_exterior light power supply 2
UF18	25A	BCM_wiper motor
UF19	15A	BCM_tail gate motor
UF20	15A	BCM_turn signal light
UF21	10A	BCM_interior light power supply
UF22	5A	Dimmer motor
UF23	20A	Driver window regulator switch
UF24	20A	Front occupant window regulator switch
UF25	10A	MCU
UF26	10A	VCU (constant power supply)
UF27	25A	ABS valve
UF28	10A	BMS
UF29	10A	PDU/AC charging port
UF30	/	Reserved
UF31	5A	Relay coil B+
UF32	/	Reserved
UF33	/	Reserved
UF34	20A	VCU
UF35	15A	Electronic water pump
UF36	5A	Relay coil end_Main



# Emergency Troubleshooting

Fuse	Specs	Function
UF37	/	Reserved
UF38	/	Reserved
UF39	15A	IEC_IG power
UF40	10A	MCU
UF41	5A	ABS controller
UF42	5A	VCU/BMS
UF43	5A	Compressor/pedestrian reminder
UF44	10A	PDU/blower relay coil end
UF45	/	Reserved

## Battery fuse box

Battery fuse box is located on the battery positive terminal.

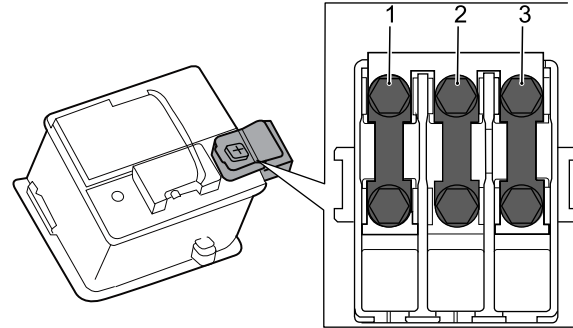

3

## Specifications of battery fuse

Fuse	Specs	Function
SB1	150A	Front compartment fuse box main fuse
SB2	80A	EPS (electric power steering system)
SB3	200A	DC-DC converter

# Emergency Troubleshooting

## Replacing fuse

**!** Only replace with fuses of the same specifications/rated current. Installing nonspecific fuse will damage electrical system and even cause fire. Before attempting to replace the fuse, the power switch and all electrical equipment shall be turned off. Any unauthorized change to vehicle electrical system will cause serious adverse effect and fire on the electronic management system.

Pull the fuse outward with puller provided in fuse box to remove the fuse. Internal wiring of the fuse can be used to identify blown fuse (arrowed).

**Note:** *Repeated failure with the same fuse is the indication of circuit failure. Please contact our Service Dealer as soon as possible.*

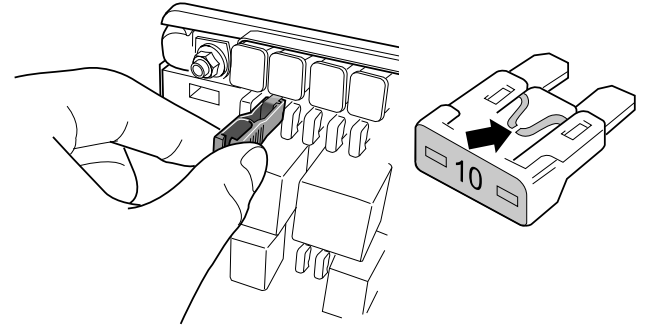

### Caution

Unauthorized changes to electrical system will make warranty invalid.

# Emergency Troubleshooting

## Replacing bulbs

Before replacing any bulbs, turn off power switch and light switch to prevent any possible short circuit.

When removing or installing bulbs, never touch the bulb with hands and if touched, clean hand trace on the bulb with cloth or alcohol.

### Caution

Replace with bulb of the same category and specification as the original one.

## Bulb specification

Bulb	Specification
Low beam	H7 55W
High beam	H1 55W
Front turn signal light	PY21W 21W
Front position light	W5W 5W
Rear turn signal light	PY21W 21W
Side turn signal light	LED
Reverse light	W16W 16W
Rear fog light	P21W 21W
Brake light/Rear position light	P21/5W 21/5W
Brake high level light	LED
License plate light	W5W 5W
Front roof vanity light	C5W 5W
Rear roof vanity light	C5W 5W

Bulb removal procedures are as below (no re-description for installing procedures as they are the reverse of removal) and for other bulbs not listed for replacement, our Service Dealer shall be contacted for inspection as soon as possible.

# Emergency Troubleshooting

## Low beam

Open front compartment hood.

At the back of the headlamps:

- Turn lamp cover anti-clockwise to remove it.
- Carefully disconnect the pin connector.
- Release spring clip and turn it out.
- Remove the bulb.

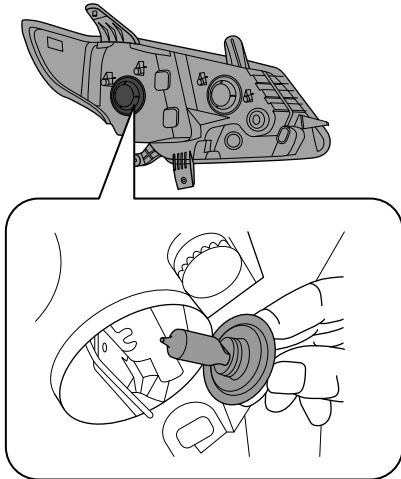

## High beam, position light

Open front compartment hood.

At the back of the headlamps:

- Turn lamp cover anti-clockwise to remove it.
- Remove the high beam bulb, position light bulb and position light bulb holder.

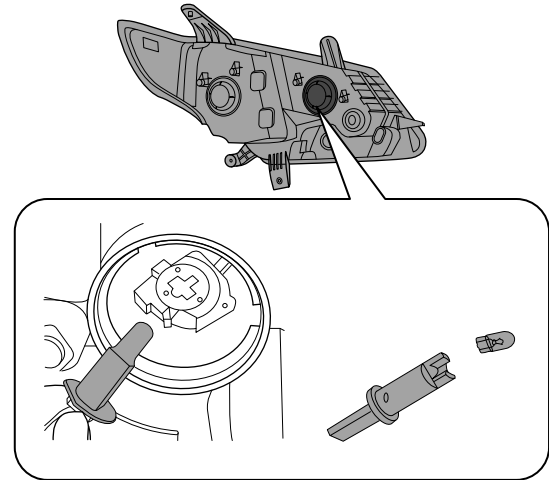

# Emergency Troubleshooting

## Front turn signal light

Open front compartment hood.

At the back of the headlamps:

- Turn the lamp holder anti-clockwise to remove it together with the turn signal light.
- Remove the turn signal light bulb and holder.

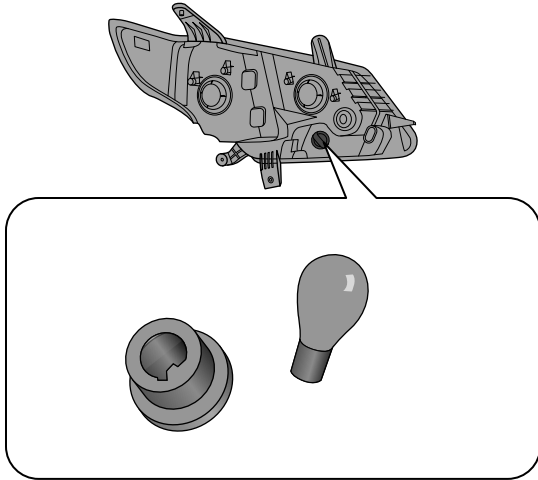

## Front roof vanity light

Carefully pry the lamp shade with a screwdriver or similar tools.

Remove the bulb.

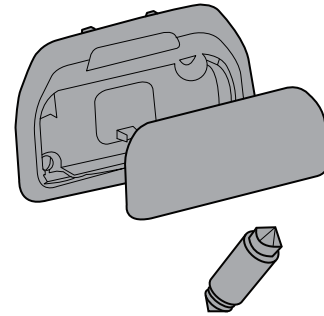

3

## Emergency Troubleshooting

---

### Rear roof vanity light

Carefully pry the lamp shade with a screwdriver or similar tools.

Remove the bulb.

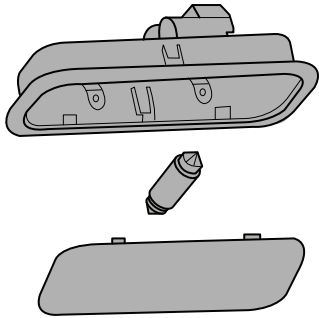

## **Maintenance and Service**

---

- 144 Scheduled maintenance
- 144 Owner's check
- 145 Front compartment
- 146 Front compartment hood
- 148 Coolant
- 149 Brake fluid
- 150 Washer fluid
- 151 Washer jet
- 151 Wiper blade
- 152 Seat belt
- 153 Battery
- 157 High-voltage battery pack
- 159 Tires
- 161 Other maintenance

# Maintenance and Service

---

## Scheduled maintenance

Regular maintenance is the key to economy, safety and reliability for your vehicle and it must be remembered that the responsibility for maintaining your vehicle in a safe, roadworthy condition rests ultimately on you, the owner/operator.

Necessary maintenance and the intervals have been specified to maintain your vehicle properly. Regular vehicle maintenance shall be done by our Service Dealer in accordance with Warranty & Service Handbook.

It is in your best interest to have your vehicle regularly maintained in accordance with regulations.

Our Service Dealers are recommended as they have qualified personnel, required facilities and can offer the unique pre-planned service which will give maximum vehicle reliability.

## Owner's check

The following are a few simple but important checks which you should make at regular intervals before driving to ensure reliable, economic operation:

### Daily checks

- Operation of all lights (ensure all lenses are clean), horn, instrument cluster, warning lights and indicators, windshield wipers and washers.
- Operation of seat belts.
- Correct functioning of brakes.
- Visually check for signs of water, oil, exhaust and other leaks under the vehicle.



# Maintenance and Service

## Weekly checks or check before a long journey

- Check for fluid level / fluid fill-up.
  - Coolant
  - Brake fluid
  - Windshield washer fluid
- Check for condition and pressure of all tires.
- Check and operate AC system.

## Arduous use

For vehicles often subject to arduous use it is recommended that service intervals are reduced. Regular vehicle maintenance shall be done by our Service Dealer in accordance with Warranty & Service Handbook.

## Front compartment

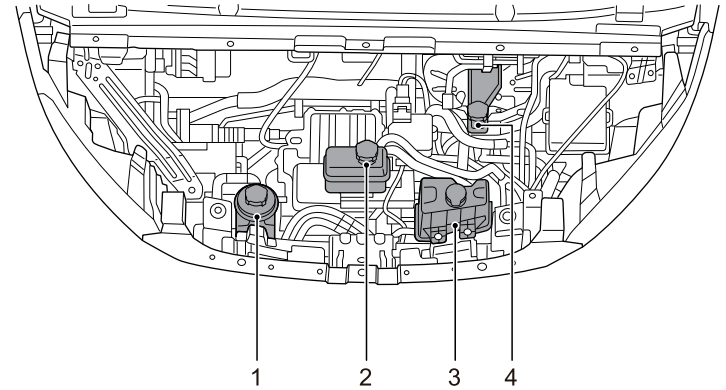

- 1 Electric drive system coolant expansion tank
- 2 Battery circulation system coolant expansion tank
- 3 Washer fluid reservoir
- 4 Brake fluid reservoir

## Front compartment hood

### Open front compartment hood

- 1 Pull the hood release switch below the driver side lower guard to release the hood.

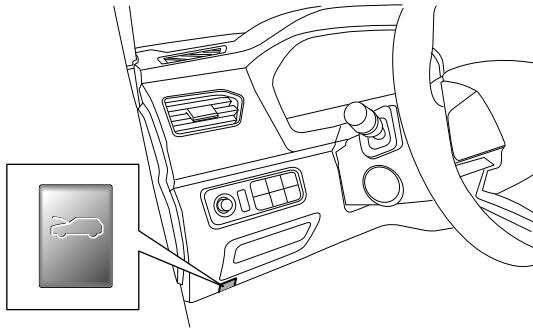

- 2 Lift the front compartment hood lock lever upward to unlock.
- 3 After unlocking, lift the front compartment hood slightly (about 10 cm). Do not lift the front compartment hood too much, or the front compartment hood inner panel pin may be broken. Hold the edge of the front compartment hood and pull it forward to disengage the front compartment hood inner panel pin from the hinge (small buckle), then remove the front compartment hood.

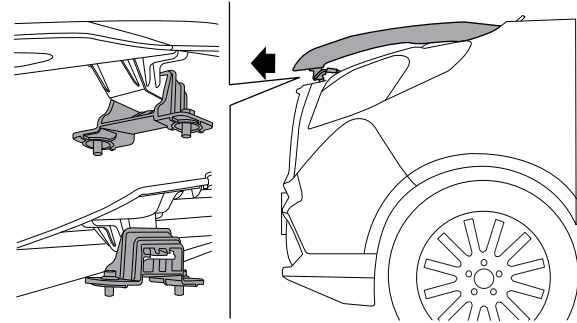

- 4 Lay the removed front compartment hood flat so as to protect its surface. Never use the corner of the front compartment hood to support itself, or the paint may be damaged.

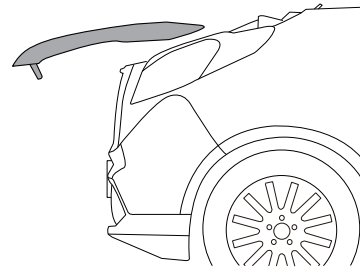

## Maintenance and Service

### Close front compartment hood

1 To close the front compartment hood, hold the two side edges and align the two side pins with the small buckles, and then insert them into the end.

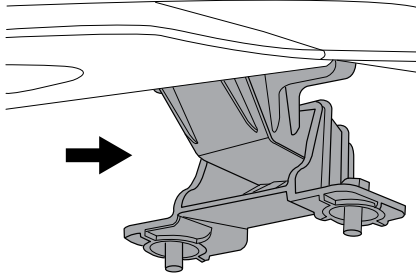

2 After aligning the side lockpins of the front compartment hood with the bodyside lock holes, press the front outer surface of the front compartment hood to completely engage the lockpins. Attempt to pull the front compartment hood upwards to check that the lock mechanism is engaged properly.

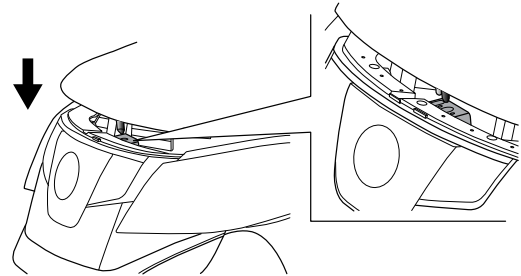

4

#### Caution

Before closing, check that no tools, rags, equipment, etc. remained in the area under the front compartment hood.

# Maintenance and Service

---

## Coolant

 **Coolant is harmful if swallowed. Do not allow antifreeze to contact the eyes or skin. If it does, rinse immediately with plenty of water.**

Please add correct specification coolant. Never drive the vehicle if coolant of correct specification is not filled. Coolant specification see "Recommended fluid oil".

At specified intervals the cooling system should be drained, flushed and refilled with the correct amount of coolant.

### Caution

When charging or replacing coolant, only specified coolant can be used. The use of non-recommended coolant could cause damage to the cooling system and may invalidate the warranty.

## Inspection and refill

 **Do not open the expansion tank cap when the system is in hot condition, otherwise you may be injured by water vapor or hot coolant. If coolant has to be charged when the system is hot, wait for 10 minutes, place a thick cloth over the filler cap and turn the cap slowly anti-clockwise to release the pressure in the expansion tank before removing the cap.**

Always check the coolant level with the vehicle on level ground and the coolant system stationary (cold condition).

The level is visible in coolant expansion tank and normal level shall be between 'MAX' and 'MIN' marks.

If the level drops to 'MIN' mark, clean area around the coolant expansion tank cap and then turn anti-clockwise to remove it. Top up with the specified fluid between 'MAX' and 'MIN' marks. Install the expansion tank cap.

***Note: Coolant expands when it gets hot, and the level may then be higher than the level mark.***

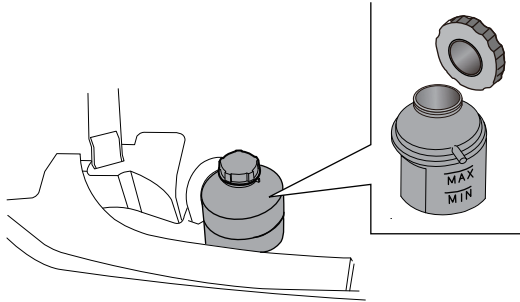

## Caution

If the level has fallen appreciably, or topping-up is required frequently, suspect leakage or overheating and contact our Service Dealer for inspection.

## Brake fluid

**!** If there is an appreciable drop in the level of the brake fluid, contact our Service Dealer as soon as possible.

Use only new, specified brake fluid. Use of old or unspecified fluids can cause loss of braking performance.

Brake fluid cleanliness is essential. Any dirt entering the system can cause loss of braking performance.

Do not allow brake fluid to contact the skin or the eyes; If it does, rinse immediately with plenty of water. Keep brake fluid out of the reach of children.

## Caution

- Only top up the brake master cylinder with brake fluid complying with specification DOT4. Do not use any other type of brake fluid.
- Brake fluid will damage paintwork if allowed to contact it. Wipe clean immediately and flush with water.

## Inspection and refill

Always check the brake fluid level with the vehicle on level ground and the brake system in cold condition. Brake fluid level is visible on the reservoir and the normal level shall be between 'MAX' and 'MIN' marks. If the level drops to 'MIN' mark, clean area around the filler cap and then turn anti-clockwise to remove

## Maintenance and Service

it. Fill up specified new brake fluid between 'MAX' and 'MIN' marks and install the reservoir cap.

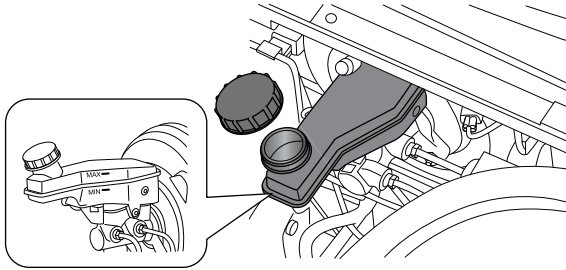

If the level falls below 'MIN' mark, "brake system warning light (red)" on the instrument cluster will come on. This indicates a fault in the braking system which must be investigated immediately. If driving, IMMEDIATELY bring the vehicle carefully to a halt. Contact our Service Dealer for service as soon as possible. Do NOT drive the vehicle.



**Never discard used brake fluid casually to avoid polluting the environment.**

## Washer fluid

### Inspection and refill

**!** Driving with a non-operational washer system can be dangerous; always check it before driving.

The windshield washer reservoir is located in the front compartment. To top up, lift the front of the filler cap to fill washer fluid and then reinstall it. Washer fluid specification see "Recommended fluid oil".

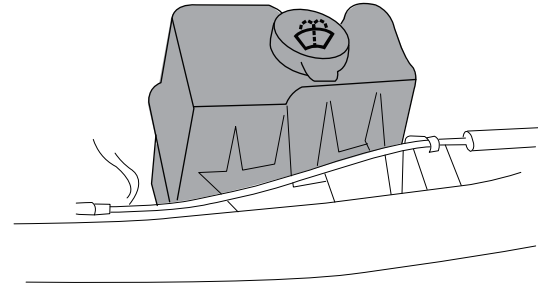

#### Caution

Do not use washer fluid that does not comply with requirements. Do not use tap water as mineral substance in tap water will easily block windshield washer fluid pipeline or jet.

## Washer jet

### Adjusting and cleaning

#### Front washer jet

Prior to carrying out jet adjustment or cleaning, ensure that the washer reservoir is topped-up. Use a piece of thin wire or a pin to carefully clean the jets if the jet is blocked.

Direction of washer jet has been set in manufacturing works and normally no adjustment required. If adjustment is required, carefully insert a fine needle into the jet hole to re-position the jet to direct the spray direction towards the middle of the windshield.

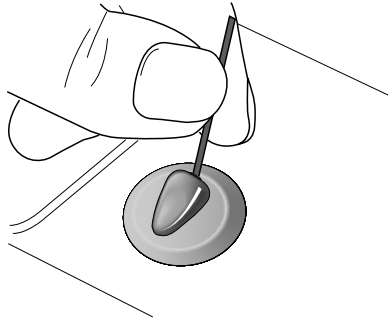

## Wiper blade

### Inspection

Examine the edge of the blade for roughness or damage, and check that the blade rubber is secure throughout its length.

**Note:** *Traces of grease and other impurities on the rubber can prevent the wipers from working correctly, and can also damage the windshield glass.*

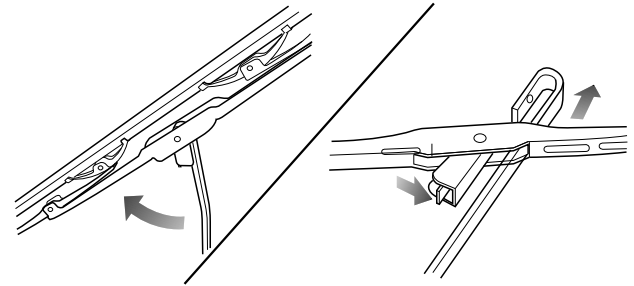

# Maintenance and Service

---

## Replacement

### Removal

— Lift the wiper arm from the windshield and position the blade at right angles to the arm.

— Push down the clip (arrowed) and slide the blade carrier down the arm to disengage the pivot on the carrier from the hook on the arm.

**Note:** *Note the relative positions of the hook and carrier as the replacement blade must be installed the same way round.*

### Installation

— Install the blade carrier over the hook.

— Engage the pivot in the hook, and then push it into position until it is heard to click into place.

## Maintenance and service

Wash with good cleaner or neutral detergent and wipe clean with soft dry cloth that is free of lint.

## Seat belt

### Inspection



The belts also have a sensitive retractor which is designed to lock only during heavy acceleration, deceleration or, for example, on tight bends.

**Do NOT attempt to test the locking device by intentionally 'launching' your upper torso in a forward direction.**

Check ALL seat belts as follows:

- Inspect all belt anchorage points for security.
- Insert the tongue into the buckle and check for a positive locking action. Check that the tongue is released cleanly when the red button is pressed.
- With the belt half unreeled, hold the tongue and give it a sharp pull. Check that the safety mechanism locks automatically and prevents further unreeling.



## Maintenance and service

 **Do not attempt to repair retractor or buckle mechanisms, or to modify the seat belts in any way. Seat belts subjected to strain as a result of an accident shall be replaced and the anchorage points checked by our Service Dealer.**

Regularly inspect the belt webbing for signs of abrasion or wear, paying particular attention to the anchorage points and adjusters.

Clean seat belts by sponging with lukewarm water and a mild soap; allow drying naturally - Do NOT heat or exposing to direct sunlight. Do not allow water to enter retractor. Never bleach or color seat belt as its strength may be reduced.

## Battery

Warning on battery :



Wear goggles!



The acid liquor in battery is strongly corrosive. Ensure to wear protective gloves and goggles!



Any open fire, spark, hard light and smoking is strictly forbidden!



Explosive gas mixture may be generated during battery recharging!



Ensure to keep any child away from the acid liquor and the battery!



**There may be risks of injury, corrosion, accident and fire during operations on the battery and any electric apparatus in the vehicle! Ensure to wear goggles. Do not let any acid or leaded grains into your eyes or onto your skin or clothes.**

**The acid liquor in battery is strongly corrosive. Ensure to wear protective gloves and goggles. Do not turn over the battery, or acid liquor may be discharged from the exhaust vent.**

## Maintenance and Service

---



If any acid liquor touched your eyes, immediately flush with clean water for several minutes before seeing the doctor. If any acid liquor spills onto your skin or clothes, immediately neutralize it with thick liquid soap, and then flush with plenty of water. If any acid liquor is swallowed accidentally, see the doctor immediately.

The acid liquor in battery is strongly corrosive. Ensure to wear protective gloves and goggles. Do not turn over the battery, or acid liquor may be discharged from the exhaust vent. If any acid liquor touched your eyes, immediately flush with clean water for several minutes before seeing the doctor. If any acid liquor spills onto your skin or clothes, immediately neutralize it with thick liquid soap, and then flush with plenty of water. If any acid liquor is swallowed accidentally, see the doctor immediately.

Any open fire, spark, hard light and smoking is strictly forbidden. During working on cables and electric devices and removing electrostatic loads, avoid generating any spark. The electrodes of battery can NEVER be short-circuited, or may cause injury due to large energy spark.

Explosive gas mixture may be generated during battery recharging. The gas vent of battery should be kept unblocked to discharge the gas correctly.



During recharging, the battery should be located in a space with good ventilation.

Ensure to keep any child away from the acid liquor and the battery.

Before working on any electrical equipment, please turn off the power switch and all of the electrical equipment. Remove the negative cable of battery. When replacing bulbs, only the lights are required to be shut down.

Pay attention to the polarities of power supply. Before powering on, the matches of polarities must be checked.

The duration of each powering on should not be less than 5 seconds. Try to avoid powering on and off too frequently.

When removing the battery, please remove the negative cable before positive cable.

Before powering on the battery again, all of the electrical equipment should be shut down. Connect the positive cable before negative cable. Never connect the cables incorrectly - risk of fire!

Unauthorized removing and installing of battery is strictly forbidden. In some cases, such operations may cause severe damage to the battery and fuse box. Please contact our Service Dealer.

 **Do not disconnect the battery when the power switch is on, otherwise may cause damage to the electrical equipment (electrical components).**

To prevent the battery housing from exposing to ultraviolet ray, do not expose the battery under the sunshine.

## Duration of storing the vehicle

If the vehicle is stored for a long time, devices consuming quiescent current (such as clock, safety device) can exhaust the power of battery, which requires to recharge the battery. To prevent this from happening, please recharge the battery or disconnect its negative cable during storing of the vehicle.

**Note: Before working on the battery, please pay attention to the warnings on battery.**

### Caution

Ensure to turn off the power switch during storing, otherwise the storing duration can be reduced significantly.

## Operating in winter

There are some strict requirements on operating the in-car battery in winter. In addition, the battery can only provide the starting power which is a part of that in normal temperature. We suggest to have the in-car battery checked by our Service Dealer before the cold season, and recharge it if necessary.

If the vehicle is not used for weeks in cold season, please remove the in-car battery and store in an ice-free room, to prevent it from freezing and damage.

## Recharging the battery with ground equipment

 **Do not recharge any frozen battery, or may cause explosion! Even if the battery is unfrozen, there may be acid liquor spilling out and cause corrosion. Any frozen battery must be replaced.**

Turn off the power switch and all of the electrical equipment before recharging.

If the vehicle has been stored for long term and cannot be started due to out of electricity (general terminal voltage $\leq$ 12V), the battery must be removed from the vehicle and recharged with ground equipment (follow the instructions provided by manufacturer of the recharging equipment).

During recharging with low current (e.g., a small recharging device), it is unnecessary to remove the connecting cables of battery. However, please ensure to read the instructions from manufacturer of the recharging device.

Before quick recharging (i.e., high current recharging), both of the cables must be removed.

**Note: Before working on the battery, please pay attention to the warnings on battery. During recharging, the recharging device can only be connected after the terminal clamps**

## Maintenance and Service

*of recharging device is connected to the electrodes of battery. After the recharging is finished, firstly turn off the recharging device, remove the power cable, and then remove the terminal clamps of recharging device from the battery.*

### Caution

- Keep any child away from the battery, acid liquor and recharging device.
- The battery can only be recharged in space with good ventilation. Smoking is strictly forbidden. Ensure to keep away from open fire and spark, because explosive gas mixture may be generated during recharging of the battery.
- Protect your eyes and face, never be too close to the battery.
- If any acid liquor touched your eyes or skin, immediately flush with clean water for several minutes before seeing the doctor.
- There is risk to quickly recharge the battery, which should be done by our Service Dealer due to requirements on special recharging device and knowledges.
- Any frozen or unfrozen battery must be replaced, because cracks may be found on the frozen housing. It may cause leak of acid liquor and damage to the vehicle.

### Removing the battery

Turn off the power switch and all of the electrical equipment before removing the battery.

To remove the battery, firstly remove the negative cable and then the positive cable. And then remove the bolt on the mounting bracket of battery to remove the battery.

### Replacing the battery

The battery installed on your vehicle is designed for the corresponding mounting location. To replace the battery, please ensure to use one with the same voltage (12V), structure and safety label. The current strength and capacity should be same with the original battery. Our Service Dealer can offer you with genuine batteries.

When replacing the battery, please ensure that the power switch is turned off and all of the electrical equipment are shut down.



**Concerning the disposal of used battery, it is suggested to have the battery replaced by our Service Dealer. Additionally, the battery can never be treated as household garbage because it contains sulfuric acid and lead.**

### Installing the battery

Before installing the battery, please turn off the power switch and shut down all of the electrical equipment.

Locate the battery into the position, and fix it with battery bracket.

When connecting the battery, please fix the positive cable before negative cable.

## Caution

To prevent the battery from discharging, please turn off the power switch when you leave the vehicle.

## High-voltage battery pack

### Instructions and restricted conditions

 **According to the characteristics of the lithium battery, the vehicle must be charged and discharged every 30 days in storage period(not limited to fast or slow charging), a long time parking easily results in damage of battery, thereby affects the running of whole vehicle. Failure to do so may result in loss or damage of the power battery, which may affect your enjoyment of the free warranty!**

Pure electric vehicle is different from the conventional vehicle, therefore it has particularity on aspects of operation, storage and maintenance, and now some cautions are informed to you.

1 The vehicle cannot be parked for over eight hours in a place where temperature is over 60°C. Vehicle cannot be parked for over 20 hours in a place where temperature is lower than -30°C. Vehicle shall not be parked for more than 7 days in a place where temperature is above 45°C. If it exceeds maximum limit of the storage environment of vehicle, it will directly affect performance of vehicle and lifetime of high voltage battery pack.

Vehicle cannot be parked in high-temperature places.

2 To better extend the service life of high-voltage battery pack, it is recommended adopting slow charging. Fast charging is mainly used for emergency and long-distance driving.

## Maintenance and Service

---

- 3 When using the vehicle, it is recommended to avoid frequent hard acceleration and deceleration, and choose flat and dry roads as much as possible when driving. If necessary, turning off high-power electrical appliances such as the air conditioning, or adjusting the A/C temperature to reduce the power consumed by high-power electrical appliances and to increase the driving range. Deep discharge will reduce the battery service life, shallow charge and shallow discharge will extend the battery service life. In low temperature, the available power of the high-voltage battery pack may be reduced, and the available power will decrease with the drop of temperature; when the vehicle with high power level is charged in a low temperature environment, the power may jump to 100%.
- 4 Vehicle will be kept dry and cannot be placed in damp environment for long time such as parking place with ponding. If the vehicle is immersed in water or waded into the water, it shall be parked in dry place.
- 5 When the vehicle is not used for a long time (more than 7 days), it is recommended to keep the high-voltage battery pack power at 40% ~ 60% to prolong the service life of the high-voltage battery pack; do not allow the vehicle to be parked for more than 7 days with the high-voltage battery pack power below 20%, please charge immediately when the power is below 5%, and parking for more than 12h is strictly prohibited, otherwise there may be a risk of over discharge of the high-voltage battery pack; it is recommended to use the vehicle at least once a month, and a slow full charge must be conducted every 3 months for the high-voltage battery pack, and then have it discharged to 40% ~ 60%, otherwise it may cause the high-voltage battery pack over discharge, which will lead to lower battery performance, or even damage, the resulting vehicle failure and damage will not be covered by the warranty.
- 6 Do not disassemble the high-voltage battery pack and related components for repair without approval, otherwise our Service Dealer will not fulfill the warranty terms.
- 7 It is recommended that a slow full charge is conducted for the vehicle every week or every 2,000 kilometers, waiting for active charging stop when charging to 100% power (that is, not actively stop the charging, waiting until the charging pile charges the vehicle high-voltage battery pack to the cut-off voltage and automatically stops charging).
- 8 High voltage battery pack is easily damaged at chassis position through scraping and collision. Therefore, you shall timely contact our Service Dealer if the vehicle has driven on abnormal pavement to check whether the high voltage battery pack has deformation or not and whether enclosure has crack or not.
- 9 If the vehicle encounters collision and scraping in the utilization process, the vehicle will be timely checked by our Service Dealer to confirm whether the high-voltage battery pack has deformation or not and whether the enclosure has crack or not; if serious accident occurs, after accident

has been disposed, you shall contact our Service Dealer to transfer the vehicle to our Service Dealer for check.

- 10 After a serious vehicle accident, personnel in the vehicle need leave the vehicle as soon as possible and contact our Service Dealer for disposal at once.
- 11 If the vehicle body need be repaired or painted due to damaged in an accident, you must contact our Service Dealer to avoid manual damage or fire disaster of high-voltage battery pack and relevant operation can be conducted after dismantling the high-voltage battery pack.
- 12 when the vehicle is used for the first time or re-used after parking for a long time, the instrument displayed power may have deviations, a full charge needs to be conducted for the vehicle.
- 13 In high or low temperature, prolonged charging time and weakened power performance may occur for the high-voltage battery pack, which is a normal phenomenon.
- 14 he power performance of high-voltage battery pack will be reduced under low battery condition, and the vehicle feedback performance will be reduced under high battery condition.

### Tires



**DEFECTIVE TIRES ARE DANGEROUS! Do NOT drive your vehicle if any tire is excessively worn or damaged, or is inflated to an incorrect pressure.**

Frequently inspect the tires and sidewalls for any sign of distortion (bulges), cuts or wear. Flints and other sharp objects should be removed with a suitable blunt tool. If neglected, they may work through the tire.

### Tire pressure



**Driving with incorrectly inflated tires can affect vehicle stability, increase rolling resistance, and cause rapid tire wear and possible permanent damage to the cords of the tire casing.**

Remember tire wear and inflation pressure regulations. It is the driver's responsibility to ensure that the tires meet these requirements.

Check the tire pressures weekly (including the spare tire), and if necessary, adjust in accordance with pressure requirements on the "tire pressure sign" on driver's door frame. This Handbook introduces the correct tire pressure in cold condition, see "Wheel and tire".

Pressure should be checked with an accurate Tire Pressure Gauge when the tire is cold instead of decreasing the value

## Maintenance and Service

---

under warm condition as the pressure will be higher than normal pressure due to temperature. Always reinstall the valve caps to prevent dirt entry into the valve mechanism.

A natural pressure loss will occur with time; any unusual pressure loss should be investigated and rectified.

**Note: The specified pressure is for cold tires; warm tire pressure will be higher.**

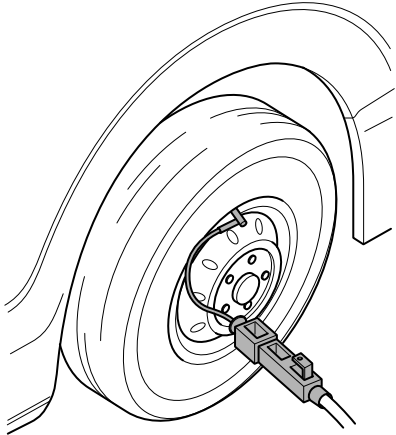

### Wear indicator

There is wear indicator in tread for all original tires. When the tire has worn down until 1.6 mm of the tread is remaining the wear indicator will appear across the full width of the tread pattern.

A tire should be replaced immediately where any part of the wear indicator becomes visible. However it is in your interest to note that tire safety and performance tends to reduce before the legal limit is reached. For example, badly worn tires will increase the risk of aquaplaning.

#### Type 1

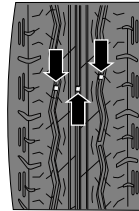

#### Type 2

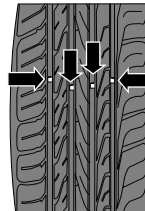



## Tire check and rotation

In order to achieve even tire wear, it is recommended to check the tires every 5,000km, and check the wheel alignment parameters under the curb weight of the entire vehicle as required. If irregular wear is found, the tires position should be changed, and wheel alignment adjustments should be made if necessary. During the tire rotation, check the tires for correct dynamic balance.

During the tire rotation, check for uneven wear and damage. Abnormal wear is usually caused by incorrect tire pressure, poor wheel alignment, poor wheel dynamic balance, emergency braking or cornering. Check the tread or the side of the tire for collision damage or bulges. If one of these conditions is found, the tire shall be replaced. If fabric or cord is visible, the tire shall also be replaced. After the tire rotation, adjust the inflation pressure of the front and rear tires as shown on the tire pressure label on the vehicle and check the tightness of the wheel nuts.

### Tire rotation method for vehicles equipped with full-size spare tires

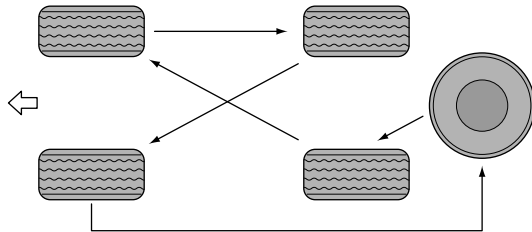

## Other maintenance

### Vehicle cleaning

**!** For first driving after washing the vehicle, gently apply the brake pedal several times to ensure all moisture is removed from the brake discs.

Carefully clean tires. Never use high pressure jet as it may damage tires. If any damage found, replace the tire.

Flushing water on the forepart of the interior car (close to the dashboard area) is prohibited so as not to cause unnecessary damage to some related parts.

Never flush the front compartment, battery compartment and surrounding connectors with water.

Careful attention to the following will help to retain the value of your vehicle:

- Clean the vehicle with cold or lukewarm water. Hot water may cause damage to vehicle paintwork under extreme cold conditions.
- No vehicle washing under strong direct sunlight during hot weather.
- Use special vehicle cleaner to remove grease and tar spots on vehicle body and while still wet, wash the paintwork using a soft sponge and generous quantities of water containing

## Maintenance and Service

---

car shampoo. Rinse thoroughly and dry off with a chamois leather.

- When using a hose to wash the vehicle, never direct the water to window, door or brake parts through wheel clearance.
- After cleaning, inspect the paintwork for damage and stone chips; apply touch-up paint if necessary. Use polishing wax to protect paintwork from time to time.
- When using high pressure cleaning equipment, the water jet shall be kept moving. Do not direct it at the door gaps, seals, electrical components or their connections.

***Note: Remove apparently harmless looking but often aggressive particles from the paintwork immediately - e.g. bird droppings, tree resins, insect remains, tar spots, road salt and industrial fall-out. Otherwise permanent staining or damage will be produced.***

### Anti-corrosion of underbody

The underbody of your vehicle has been treated with anticorrosion. Check underbody anti-corrosion regularly.

Use a water jet to remove accumulations of caked mud or debris on underbody. Especially in winter, when salt is used on icy and snowy road.

### Seat and trim

Often use vacuum sweeper or soft brush to clean dirt and dust accumulated on fibers. Often use clean cloth to wipe the trim. Use special cleaner to remove general trim dust, staining or spot. Use special cleaner to clean leather parts.

### Door seal

To prevent rubber door seals freezing during cold weather, rubber maintenance product or silicone spray shall be used for protection.

### Window glass

Often use glass cleaner to clean window glass.

The headlamp lenses are clear plastic. Use good cleaner or neutral detergent to wash rather than abrasive or chemical solvent.

## **General Technical Parameters**

164 Major vehicle dimension parameters

165 Vehicle weight parameters

166 Dynamic performance parameters

167 Major drive motor parameters

168 Chassis technical parameters

169 Recommended fluids

170 Wheel and tire

171 Wheel alignment parameters

## General Technical Parameters

### Major vehicle dimension parameters

Model	MAXUS e DELIVER 3 short wheelbase van	MAXUS e DELIVER 3 long wheelbase cab
Driving type	Front-motor, front-wheel-drive	Front-motor, front-wheel-drive
Length, mm	4555	5090
Width, mm	1780	1780
Height, mm	1900	1885
Wheelbase, mm	2910	3285
Front/Rear overhang, mm	780/865	780/1025
Front track, mm	1548	1548
Rear track, mm	1553	1553
Minimum turning circle diameter, m	11.7	13.1

## General Technical Parameters

---

### Vehicle weight parameters

Model	MAXUS e DELIVER 3 short wheelbase van	MAXUS e DELIVER 3 long wheelbase cab
Gross vehicle weight, kg	2660	2920
Curb weight, kg	1615	1515
Axle load (Front/rear axle load under gross vehicle weight), kg	1200/1460	1460/1460
Passenger capacity	2	2

## General Technical Parameters

### Dynamic performance parameters

Item		Parameter
Max. speed, km/h	Max. speed	120(van) 90(cab)
Max. reverse speed, km/h		30
Gradeability, %	Max. gradeability	30
Accelerating ability, second	Accelerating time from 0 to 50 km/h	5
Driving range, km	WLTP condition	227(short wheelbase van, 50kWh high-voltage battery pack model) 190 ~ 240(long wheelbase cab, 50kWh high-voltage battery pack model)

## General Technical Parameters

### Major drive motor parameters

Model	TZ200XSSQA
Type	Permanent magnet synchronous motor
Rated speed, r/min	4780
Peak speed, r/min	13500
Rated power, kw	50
Peak power, kw	118
Rated torque, Nm	100
Max. torque, Nm	225

## General Technical Parameters

---

### Chassis technical parameters

Item	Parameter
Front suspension	McPherson independent suspension
Rear suspension	Rear leaf spring non-independent suspension
Requirements for steel wheel dynamic balance	Residual dynamic unbalance on both sides of steel wheel assembly shall be less than 10g (main tire)
Sound free travel of brake pedal	within 10 mm
Reasonable application range of brake friction pair	For single friction plate, the friction material shall remain at least 2mm The wear on each side of the brake disc shall be less than 1.5mm



## General Technical Parameters





### Recommended fluids

Item	Specification	Capacity
Coolant (electric drive system), L	D-35(-35°C)	4.5
Coolant (battery circulation system), L	D-35(-35°C)	5.9
Brake fluid, L	Laike 901-4 DOT 4	0.66
Washer fluid, L	Universal lower freezing point washer fluid	2
Air conditioning refrigerant, g	R1234yf	550
Reducer lubricating fluid, L	Castrol BOT 352B1BEV	0.8±0.05

# General Technical Parameters

## Wheel and tire

### Main tires

Item			Parameter	
Wheel specification			5.5Jx15	
Tire specification			185/65R15 92H	185/65R15C 97/95S
Tire pressure (cold state)	Front wheel		280kPa/2.8bar/41psi	375kPa/3.75bar/54psi
			280kPa/2.8bar/41psi	375kPa/3.75bar/54psi
	Rear wheel		310kPa/3.1bar/45psi	375kPa/3.75bar/54psi
			310kPa/3.1bar/45psi	375kPa/3.75bar/54psi

### Spare tire

**Note:** *It applies to the vehicles equipped with spare tires.*

Item	Parameters
Spare tire specification	185/65R15C 97/95S
Spare tire pressure (cold state)	375kPa/3.75bar/54psi

## General Technical Parameters

### Wheel alignment parameters

Item	Parameter
Front wheel toe-in	$0^{\circ} \pm 0.09^{\circ}$ Difference between left and right $\leq 0.1^{\circ}$
Front wheel camber	$-0.333^{\circ} \pm 0.5^{\circ}$ Difference between left and right $\leq 0.5^{\circ}$
Front wheel king pin inclination angle	$12.251^{\circ} \pm 0.5^{\circ}$ Difference between left and right $\leq 0.5^{\circ}$
Front wheel king pin caster angle	$4.15^{\circ} \pm 0.75^{\circ}$ Difference between left and right $\leq 0.5^{\circ}$
Rear wheel thrust angle	$0^{\circ} \pm 0.25^{\circ}$
Rear wheel toe-in	$0^{\circ} \pm 0.42^{\circ}$
Rear wheel camber	$0^{\circ} \pm 0.5^{\circ}$